

Part number:

HYDROMA

HYDRAULICKÉ SYSTÉMY

**HIDROMA
SISTEMS**

UKŁADY HYDRAULICZNE

HYDROMA

ГИДРАВЛИЧЕСКИЕ СИСТЕМЫ

71 200/107 ED



HC3

HYDRAULIC CYLINDERS

SERIES 10

ISO 6022

DIN 24333

DESCRIPTION

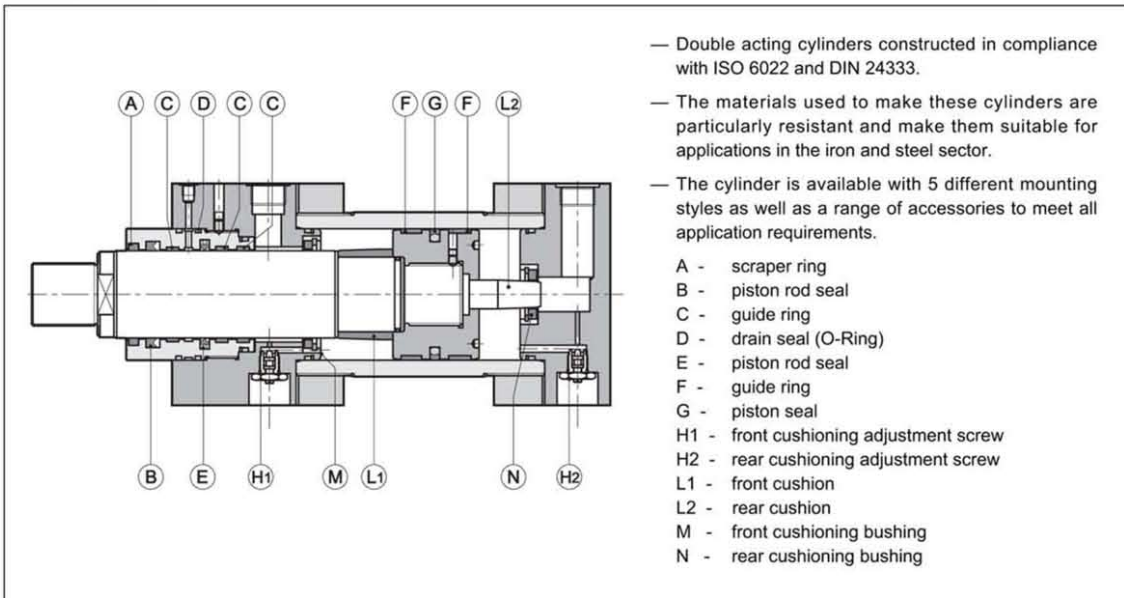

PERFORMANCE RATINGS

Nominal operating pressure (continuous service)	bar	250
Maximum operating pressure	bar	320
Maximum speed (standard)	m/s	0,5
Maximum stroke (standard)	mm	6000
Fluid temperature range (standard)	°C	-20 / +80

1 - CHARACTERISTICS

1.1 Bores and piston rods

Ø 50 to Ø 400 mm bores are available to enable a vast choice according to required force.

Two piston rod diameters are available for each bore:

- reduced piston rod with area ratio 1:1.65
- standard piston rod with area ratio 1:2

1.2 Cushionings

On request, gradual and adjustable cushioning devices can be fitted in the front and/or rear ends of the cylinder without affecting overall dimensions.

The special design of the cushionings ensures optimal repeatability also in the event of variations in fluid viscosity.

Cushioning devices are always recommended as they ensure impact-free stopping even at high speed thus reducing pressure surges and impact transferred to the mounting supports.

The cylinder ends of bores higher than 160mm with cushioning can have an additional port connected directly with the braking chamber. This connection must be used in case of application, near the cylinder, of a pressure relief valve set at 350 bar, to limit overpressures during braking. For further information and for the order identification code, please consult our technical office.

The table below shows cushioning cone lengths:

Bore (mm)	50	63	80	100	125	140	160	180	200	250	320	400
Front cone length (mm)	38	40	50	50	60	60	75	75	80	100	100	110
Rear cone length (mm)	34	42	58	49	64	64	68	73	69	101	99	108

1.3 Connections

The cylinders are supplied as standard with cylindrical BSP threads and spot facing for seal rings in compliance with ISO 1179. Connections which are oversized compared to those shown in the dimensional tables are available upon request. For further information and for the order identification code, please consult our technical office. For correct cylinder operation, fluid velocity must not exceed 5 m/s.

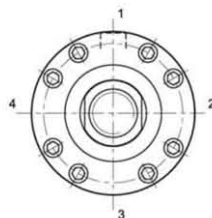

Frontal view - piston side

1.4 Connection position

Standard positions of the oil ports, cushioning adjustment screws, breathers, optional external drain and optional end-stroke proximity sensors, are indicated in the table below.

Connection positions different from the standard are available upon request. As a consequence, the other options positions will be rotated. For special requests, please consult our technical office.

	POSITION
Connections	1
Cushioning adjustment	3
Breathers	4
Drainage	1
Proximity end stroke	2
Optional port (see par. 1.2)	4

1.5 Seals

The table below illustrates seal characteristics in relation to hydraulic fluid and operating temperatures.

Type	Type of seal	Seal material	Hydraulic fluid	Minimum pressure (bar)	Operating temperature (°C)	Max speed (m/s)
K	Standard	Nitrile Polyurethane	Mineral oil	10	-20 + +80	0,5
M	Low friction	Nitrile PTFE	Mineral oil Water glycole	20 (note)	-20 + +80	15
V	High temperature and/or aggressive fluids	Viton PTFE	Special fluids	10	-20 + +150	1

Note: for lower pressure use consult our technical office.

1.6 Strokes

Standard cylinders are available with strokes up to 6000 mm.

Longer cylinder strokes can be supplied on request.

Stroke tolerances are:

0 + 1 mm for strokes up to 1000 mm

0 + 4 mm for strokes up to 6000 mm.

1.7 Spacers

In the case of cylinder strokes above 1000 mm we recommend the use of spacers which can be inserted to reduce loads on the piston rod bushing and prevent the piston from sticking.

Spacers are constructed in hardened and tempered steel with PTFE facing.

Every spacer is 50 mm long. We recommend to insert 1 spacer for strokes from 1001 to 1500 mm, with an increment of 1 spacer for every 500 mm stroke.

You must remember that the overall length of the cylinder increases according to the number of inserted spacers (50 mm for each spacer).

1.8 Drainage

A connection for external drainage on the front end can be supplied upon request, for fluid drops recovery of the first seal of the rod, without any modification to the overall dimensions.

Connection: 1/8" BSP for bore up to Ø 100 included - 1/4" BSP for higher bores.

1.9 Breathers

On request cylinder ends can be supplied with breathers for the elimination of air. This is necessary when the entire stroke is not used or when connections are not facing upwards.

1.10 Surface finish

The cylinders are supplied painted with Duplomatic black opaque colour with a paint thickness of 40 µ. The rod is chromed.

HC3

SERIES 10

2 - IDENTIFICATION CODE

H C 3 - / / - - - - / / 10

TIPO DI FISSAGGIO



A=Flangia anteriore (MF3)

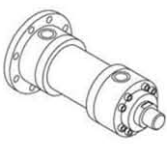

B=Flangia posteriore (MF4)



D=Occhiolo (MP3)



F=Snodo sferico (MP5)

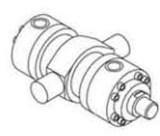

L=Oscillante centrale (MT4)

Series (indicate for spare parts requests)

Dimension XV for "L" mounting (omit for other mounting styles)

No. of spacers multiple of 50 mm (omit if not required) see par. 1.7

Back end connection position (1-4) (see par. 1.4)

Front end connection position (1-4) (see par. 1.4)

Drainage (see par. 1.8)

0 = without drainage

E = external drainage with connection on the front end

Breathers (see par. 1.9)

0 = without breathers

S = front and back breathers

Cushioning (see par. 1.2):

0 = without cushioning

1 = front

2 = back

3 = front and back

Seals (see par. 1.5):

K = standard (nitrile + polyurethane)

M = low friction (nitrile + PTFE)

V = high temperature (viton + PTFE)

Stroke (mm)

(For cylinders with spacers indicate the working stroke)

Double rod threading (omit if not required). See single rod for dimensions

Double rod (omit if not required)

See single rod for dimensions. Not available with mounting style D-F

Rod threading: Male thread (standard)

W = Female thread

(see par. 3)

Ø Rod (mm)		Rods available for each bore											
32	36	•											
40	45		•										
50	56			•									
63	70				•								
80	90					•							
90	100						•						
100	110							•					
110	125								•				
125	140									•			
160	180										•		
200	220											•	
250	280												•
Bore (mm)		50	63	80	100	125	140*	160	180*	200	250	320	400

* Bores not considered by the law ISO 6022

HC3

SERIES 10

3 - OVERALL AND MOUNTING DIMENSIONS

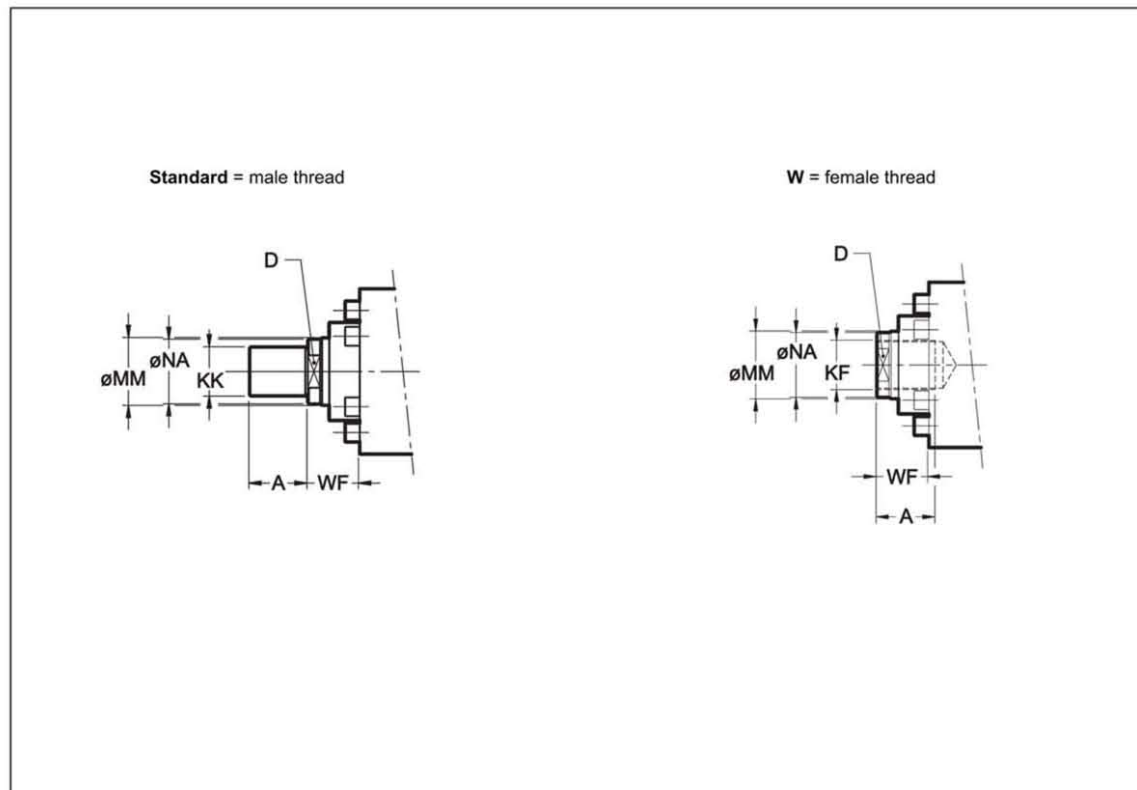

* For bores $\varnothing 180$ (piston rod $\varnothing 90$) and higher, the rod has 4 holes at 90° realized on $\varnothing NA$ and of \varnothing shown in the table.
A pin wrench UNI 6752 - DIN 1810 must be used.

Dimensions in mm

Bore	MM \varnothing rod	KK	$\varnothing NA$	KF	A	D	WF
50	32	M27x2	31	-	36	28	47
	36		35	M27x2		32	
63	40	M33x2	38	-	45	34	53
	45		43	M33x2		36	
80	50	M42x2	48	-	56	43	60
	56		54	M42x2		46	
100	63	M48x2	60	-	63	53	68
	70		67	M48x2		60	
125	80	M64x3	77	-	85	65	76
	90		87	M64x3		75	
140	90	M72x3	87	-	90	75	76
	100		96	M72x3		85	
160	100	M80x3	96	-	95	85	85
	110		106	M80x3		95	
180	110	M90x3	106	-	105	95	95
	125		121	M90x3		$\varnothing 12^*$	
200	125	M100x3	121	-	112	$\varnothing 12^*$	101
	140		136	M100x3			
250	160	M125x4	155	-	125	$\varnothing 15^*$	113
	180		175	M125x4			
320	200	M160x4	195	-	160	$\varnothing 15^*$	136
	220		214	M160x4			
400	250	M200x4	245	-	200	$\varnothing 20^*$	163
	280		270	M200x4			

HC3

SERIES 10

4 - OVERALL AND MOUNTING DIMENSIONS ISO MF3

A FRONT FLANGE

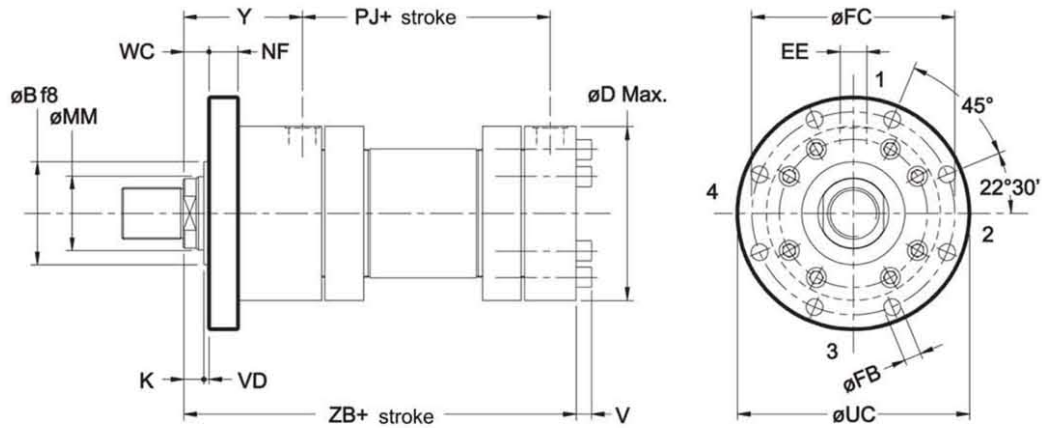

NOTE: $\varnothing 400$ bore has 12 equally spaced $\varnothing FB$ holes in the mounting flange

Dimensions in mm

Bore	MM \varnothing rod	$\varnothing B$ f8	$\varnothing D$ max	EE BSP	$\varnothing FB$	$\varnothing FC$	K	NF	PJ	$\varnothing UC$	V	VD	WC	Y	ZB
50	32 36	63	105	1/2"	13,5	132	18	25	120	155	8	4	22	98	244
63	40 45	75	122	3/4"	13,5	150	21	28	133	175	10	4	25	112	274
80	50 56	90	145	3/4"	17,5	180	24	32	155	210	12	4	28	120	305
100	63 70	110	175	1"	22	212	27	36	171	250	16	5	32	134	340
125	80 90	132	210	1"	22	250	31	40	205	290	16	5	36	153	396
140	90 100	145	255	1.1/4"	26	300	31	40	208	340	24	5	36	181	430
160	100 110	160	270	1.1/4"	26	315	35	45	235	360	24	5	40	185	467
180	110 125	185	315	1.1/4"	33	365	40	50	250	420	27	5	45	205	505
200	125 140	200	330	1.1/4"	33	385	40	56	278	440	24	5	45	220	550
250	160 180	250	410	1.1/2"	39	475	42	63	325	540	27	8	50	260	652
320	200 220	320	510	2"	45	600	48	80	350	675	36	8	56	310	764
400	250 280	400	628	2"	45 note	720	53	100	355	800	42	10	63	310	775

HC3

SERIES 10

5 - OVERALL AND MOUNTING DIMENSIONS ISO MF4

B BACK FLANGE

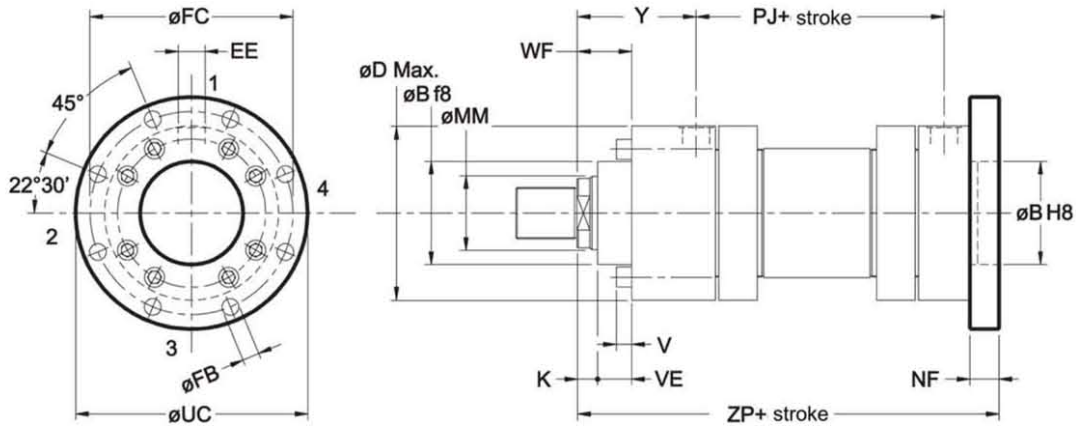

NOTE: $\varnothing 400$ bore has 12 equally spaced $\varnothing FB$ holes in the mounting flange

Dimensions in mm

Bore	MM \varnothing rod	$\varnothing B$ f8	$\varnothing D$ max	EE BSP	$\varnothing FB$	$\varnothing FC$	K	NF	PJ	$\varnothing UC$	V	VE	WF	Y	ZP
50	32 36	63	105	1/2"	13,5	132	18	25	120	155	8	29	47	98	265
63	40 45	75	122	3/4"	13,5	150	21	28	133	175	10	32	53	112	298
80	50 56	90	145	3/4"	17,5	180	24	32	155	210	12	36	60	120	332
100	63 70	110	175	1"	22	212	27	36	171	250	16	41	68	134	371
125	80 90	132	210	1"	22	250	31	40	205	290	16	45	76	153	430
140	90 100	145	255	1.1/4"	26	300	31	40	208	340	24	45	76	181	465
160	100 110	160	270	1.1/4"	26	315	35	45	235	360	24	50	85	185	505
180	110 125	185	315	1.1/4"	33	365	40	50	250	420	27	55	95	205	550
200	125 140	200	330	1.1/4"	33	385	40	56	278	440	24	61	101	220	596
250	160 180	250	410	1.1/2"	39	475	42	63	325	540	27	71	113	260	703
320	200 220	320	510	2"	45	600	48	80	350	675	36	88	136	310	830
400	250 280	400	628	2"	45 note	720	53	100	355	800	42	110	163	310	855

HC3

SERIES 10

6 - OVERALL AND MOUNTING DIMENSIONS ISO MP3

D MALE CLEVIS (with bushing)

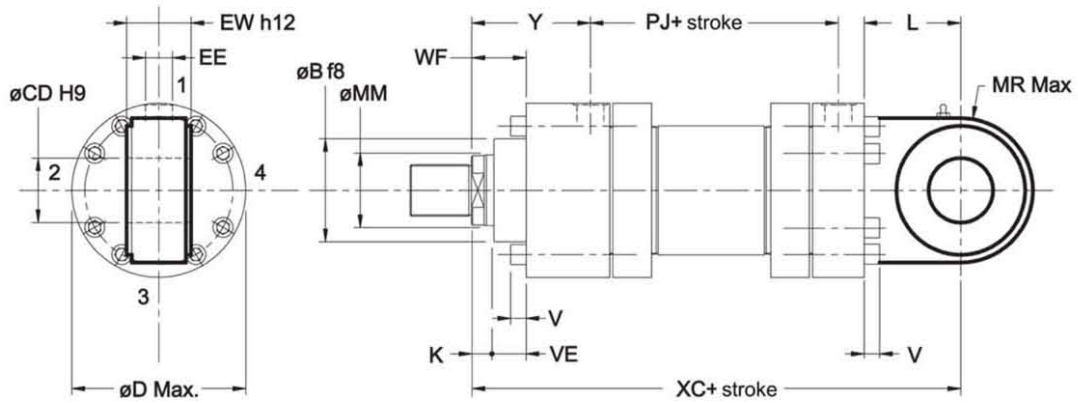

Dimensions in mm

Bore	MM \varnothing rod	$\varnothing B$ f8	$\varnothing CD$ H9	$\varnothing D$ max	EE BSP	EW h12	K	L	MR max	PJ	V	VE	WF	XC	Y
50	32 36	63	32	105	1/2"	32	18	61	40	120	8	29	47	305	98
63	40 45	75	40	122	3/4"	40	21	74	50	133	10	32	53	348	112
80	50 56	90	50	145	3/4"	50	24	90	63	155	12	36	60	395	120
100	63 70	110	63	175	1"	63	27	102	71	171	16	41	68	442	134
125	80 90	132	80	210	1"	80	31	124	90	205	16	45	76	520	153
140	90 100	145	90	255	1.1/4"	90	31	150	113	208	24	45	76	580	181
160	100 110	160	100	270	1.1/4"	100	35	150	112	235	24	50	85	617	185
180	110 125	185	110	315	1.1/4"	110	40	185	147,5	250	27	55	95	690	205
200	125 140	200	125	330	1.1/4"	125	40	206	160	278	24	61	101	756	220
250	160 180	250	160	410	1.1/2"	160	42	251	200	325	27	71	113	903	260
320	200 220	320	200	510	2"	200	48	316	250	350	36	88	136	1080	310
400	250 280	400	250	628	2"	250	53	300	320	355	42	110	163	1075	310

HC3

SERIES 10

7 - OVERALL AND MOUNTING DIMENSIONS ISO MP5

F SPHERIC SWIVEL

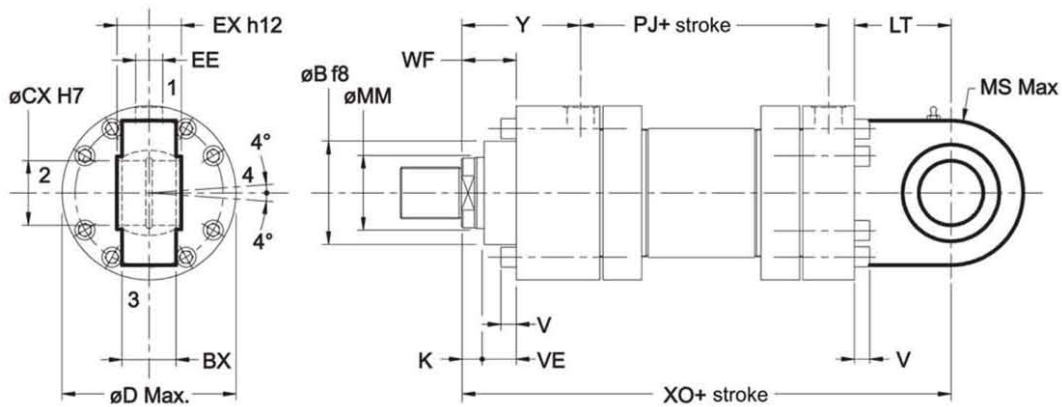

Dimensions in mm

Bore	MM \varnothing_{rod}	$\varnothing B$ f8	BX	$\varnothing CX$ H7	$\varnothing D$ max	EE BSP	EX h12	K	LT	MS max	PJ	V	VE	WF	XO	Y
50	32 36	63	27	32	105	1/2"	32	18	61	40	120	8	29	47	305	98
63	40 45	75	35	40	122	3/4"	40	21	74	50	133	10	32	53	348	112
80	50 56	90	40	50	145	3/4"	50	24	90	63	155	12	36	60	395	120
100	63 70	110	52	63	175	1"	63	27	102	71	171	16	41	68	442	134
125	80 90	132	60	80	210	1"	80	31	124	90	205	16	45	76	520	153
140	90 100	145	65	90	255	1.1/4"	90	31	150	113	208	24	45	76	580	181
160	100 110	160	84	100	270	1.1/4"	100	35	150	112	235	24	50	85	617	185
180	110 125	185	80	110	315	1.1/4"	110	40	185	147,5	250	27	55	95	690	205
200	125 140	200	102	125	330	1.1/4"	125	40	206	160	278	24	61	101	756	220
250	160 180	250	130	160	410	1.1/2"	160	42	251	200	325	27	71	113	903	260
320	200 220	320	162	200	510	2"	200	48	316	250	350	36	88	136	1080	310
400	250 280	400	192	250	628	2"	250	53	300	320	355	42	110	163	1075	310

HC3

SERIES 10

8 - OVERALL AND MOUNTING DIMENSIONS ISO MT4

L MID SWINGING

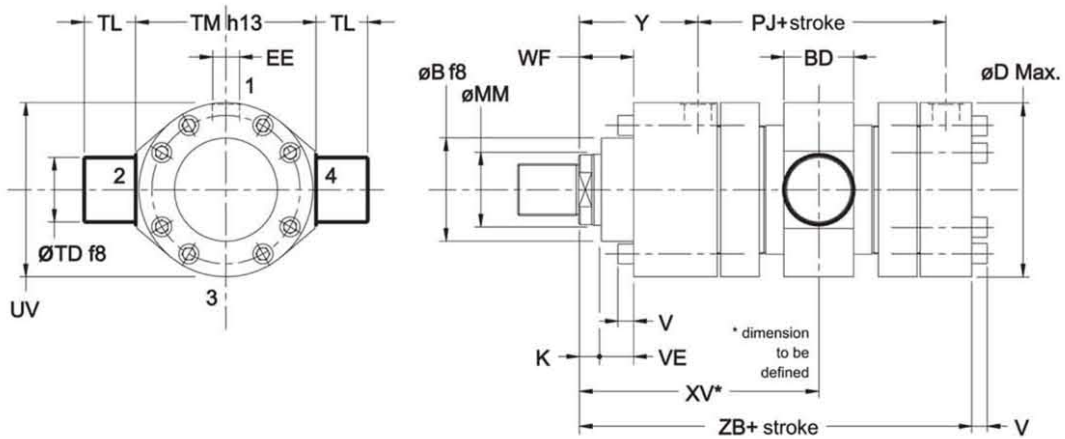

Dimensions in mm

Bore	MM Ø rod	ØB f8	BD	STROKE min	ØD max	EE BSP	K	PJ	ØTD f8	TL	TM h13	ØUV	V	VE	WF	XV min	XV max + stroke	Y	ZB
50	32 36	63	38	45	105	1/2"	18	120	32	25	112	105	8	29	47	180	144	98	244
63	40 45	75	48	45	122	3/4"	21	133	40	32	125	122	10	32	53	195	160	112	274
80	50 56	90	58	60	145	3/4"	24	155	50	40	150	145	12	36	60	220	175	120	305
100	63 70	110	73	80	175	1"	27	171	63	50	180	175	16	41	68	245	185	134	340
125	80 90	132	88	95	210	1"	31	205	80	63	224	210	16	45	76	290	220	153	396
140	90 100	145	98	115	255	1.1/4"	31	208	90	70	265	255	24	45	76	330	240	181	430
160	100 110	160	108	115	270	1.1/4"	35	235	100	80	280	270	24	50	85	340	255	185	476
180	110 125	185	118	150	315	1.1/4"	40	250	110	90	320	315	27	55	95	390	270	205	505
200	125 140	200	133	180	330	1.1/4"	40	278	125	100	335	330	24	61	101	430	280	220	550
250	160 180	250	180	220	410	1.1/2"	42	325	160	125	425	410	27	71	113	505	320	260	652
320	200 220	320	220	260	510	2"	48	350	200	160	530	510	36	88	136	590	380	310	764
400	250 280	400	270	340	628	2"	53	355	250	200	630	628	42	110	163	630	340	310	775

9 - OVERALL AND MOUNTING DIMENSIONS

DOUBLE ROD

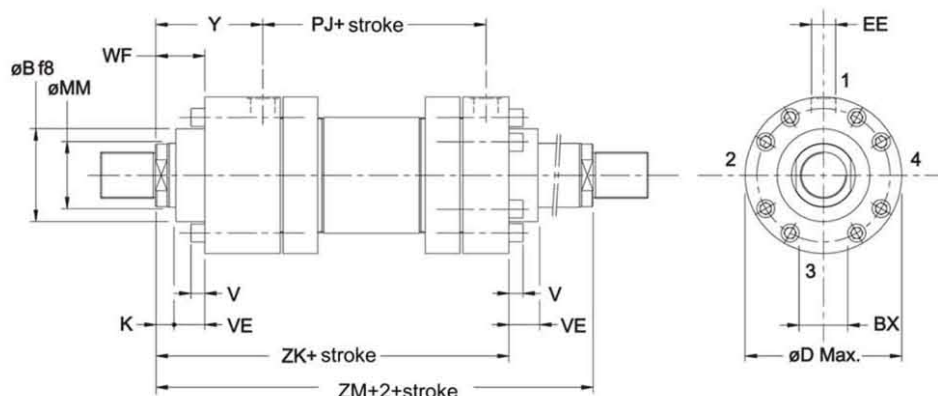

For other dimensions and mounting styles please see single rod cylinder tables.

Not available for mounting styles D-F.

Rear end dimensions for mounting style B are like those of the front end corresponding to mounting style A.

Dimensions in mm

Bore	MM Ø _{rod}	K	PK	V	VE	WF	Y	ZM	ZK
50	32 36	18	126	8	29	47	98	322	275
63	40 45	21	134	10	32	53	112	358	305
80	50 56	24	153	12	36	60	120	393	333
100	63 70	27	165	16	41	68	134	433	365
125	80 90	31	204	16	45	76	153	510	434
140	90 100	31	208	24	45	76	181	570	494
160	100 110	35	225	24	50	85	185	595	510
180	110 125	40	250	27	55	95	205	660	565
200	125 140	40	271	24	61	101	220	711	610
250	160 180	42	308	27	71	113	260	828	715
320	200 220	48	350	36	88	136	310	970	834
400	250 280	53	355	42	110	163	310	975	812

NOTE: Double rod cylinders are developed with two separate rods, fixed together by means of threading. Because of this mounting style, the rod with female threading is less resistant than the other. To simplify the identification of the more resistant rod, the "M" marking is stamped on its end. We recommend the use of the weaker rod for the less demanding applications.

HC3

SERIES 10

10 - ROD DIAMETER SELECTION

To ensure adequate stability, cylinders must be calculated for maximum compressive load according to the following simplified procedure:

- Refer to the table to identify the stroke factor according to the mounting style.
- To calculate the reference length, multiply the working stroke by the stroke factor.

- To calculate the thrust force, multiply the total cylinder area by the operating pressure.

- On the diagram, find the point of intersection between the thrust force and reference length.
- Identify the minimum rod diameter on the curve above the previous point of intersection.

Cylinders with rod diameters smaller than the value plotted in the diagram will not guarantee sufficient rigidity.

Mounting style	Rod connection	Mounting	Stroke factor
A	Fixed and supported		2
	Fixed and rigidly guided		0.5
	Jointed and rigidly guided		0.7
B	Fixed and supported		4
	Fixed and rigidly guided		1
	Jointed and rigidly guided		1.5

Mounting style	Rod connection	Mounting	Stroke factor
D - F	Jointed and supported		4
	Jointed and rigidly guided		2
L	Jointed and supported		3
	Jointed and rigidly guided		1.5

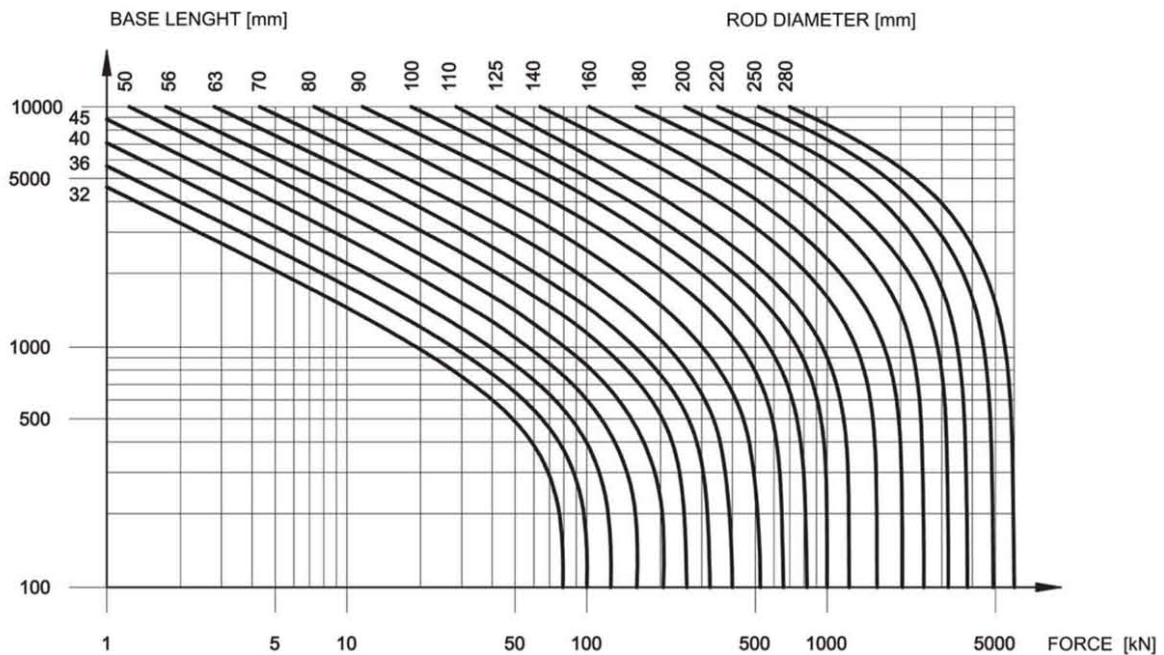

HC3

SERIES 10

11 - THEORETICAL FORCES

Push force

$$F_s = P \cdot A_t$$

Pull force

$$F_t = P \cdot A_a$$

F_s = Force (extension) in N

F_t = Force (retraction) in N

A_t = Total area in mm^2

A_a = Annular area in mm^2

P = Pressure in MPa

1 bar = 0.1 MPa

1 kgf = 9.81 N

Bore mm	Ø rod mm	Total area mm^2	Annular area mm^2
50	32 36	1964	1159 946
63	40 45	3117	1861 1527
80	50 56	5027	3063 2564
100	63 70	7854	4737 4006
125	80 90	12272	7245 5910
140	90 100	15394	9032 7540
160	100 110	20106	12252 10603
180	110 125	25447	15943 13175
200	125 140	31416	19144 16022
250	160 180	49087	28981 23640
320	200 220	80425	49009 42412
400	250 280	125664	76576 64089

12 - THEORETICAL VELOCITIES

Configuration 1

The diagram illustrates a conventional cylinder application: the fluid is delivered by means of a directional control valve in alternation to the front chamber while the rear chamber is connected to tank and vice versa.

To calculate velocity and force, proceed as follows:

$$\text{Velocity (extension)} \quad V = \frac{Q \cdot 1000}{A_t \cdot 60}$$

$$\text{Velocity (retraction)} \quad V = \frac{Q \cdot 1000}{A_a \cdot 60}$$

$$\text{Force (extension)} \quad F = P \cdot A_t$$

$$\text{Force (retraction)} \quad F = P \cdot A_a$$

V = Velocity in m/s

Q = Flow rate in l/min

A_t = Total area (piston bore) in mm^2

A_a = Annular area ($A_t - A_s$) in mm^2

F = Force in N

P = Pressure in MPa

A_s = Rod area ($A_t - A_a$) in mm^2

Q_d = Flow rate through directional control valve (Q +return flow rate from small chamber) in l/min

1 bar = 0.1 MPa

1 kgf = 9.81 N

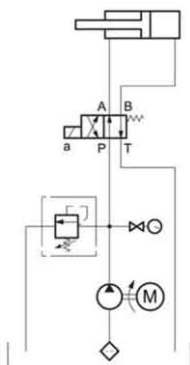

Configuration 2

When the system requires high velocity with relatively low forces, we recommend using a regenerative circuit. Diagram 2 illustrates the simplest version of this type of set-up. The annular chamber is permanently connected to the pump while the full bore end is connected alternately to the pump, in which case the piston rod extends as a result of the differential areas (both chambers are supplied at the same pressure), and to tank, in which case the piston rod retracts.

$$\text{Velocity (extension)} \quad V = \frac{Q \cdot 1000}{A_s \cdot 60}$$

$$\text{Velocity (retraction)} \quad V = \frac{Q \cdot 1000}{A_a \cdot 60}$$

$$\text{Force (extension)} \quad F = P \cdot A_s$$

$$\text{Force (retraction)} \quad F = P \cdot A_a$$

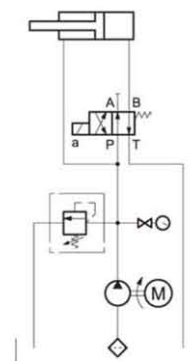

NOTE: In the case of regenerative circuits, the sizing of the directional control valve is fundamental. Flow rate through the directional control valve is calculated according to the following formula:

$$Q_d = \frac{V \cdot A_t \cdot 60}{1000}$$

HC3

SERIES 10

13 - MASSES

Bore	Ø rod	Mass for null stroke			Mass for 10 mm stroke
		Mounting style			
		A - B	D - F	L	
mm	mm	kg	kg	kg	kg
50	32 36	14	16	17	0,2
63	40 45	28	27	27	0,3
80	50 56	39	38	39	0,5
100	63 70	61	62	63	0,6 0,7
125	80 90	103 104	107 108	110	0,9 1
140	90 100	164	173	175	1,1 1,2
160	100 110	198 199	210	208 209	1,6 1,7
180	110 125	289	296 297	298 299	2 2,2
200	125 140	356 357	365 366	364 365	2,2 2,4
250	160 180	666 667	698 700	685 687	3,2 3,6
320	200 220	1200 1250	1314 1365	1259 1310	5,1 5,6
400	250 280	2180 2250	2259 2330	2249 2320	7 7,5

14 - SEAL KIT IDENTIFICATION CODE

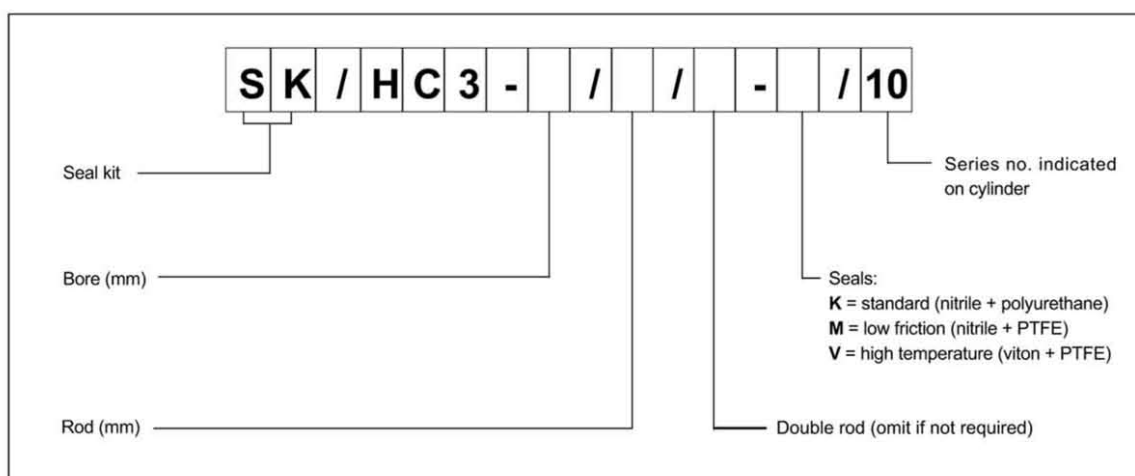

NOTE: the seal kit includes all the seals of a full-options cylinder (cushionings and external drain).

HC3

SERIES 10

15 - END-STROKE PROXIMITY SENSORS

On request, cylinders can be supplied with end-stroke proximity sensors type PNP, with normally open output. They are mounted on the front and rear end of the cylinder and they supply an electric signal when the piston rod reaches the stroke end. They are available for all cylinder mounting styles, on both ends and for every available bore.

In order to ensure the correct functioning of the system, cylinders must be equipped with cushionings.

These sensors can be only used to provide the switching signal and not to control voltage loads.

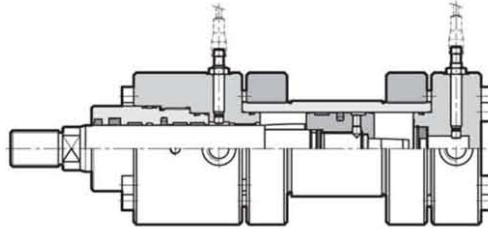

15.1 - Identification code

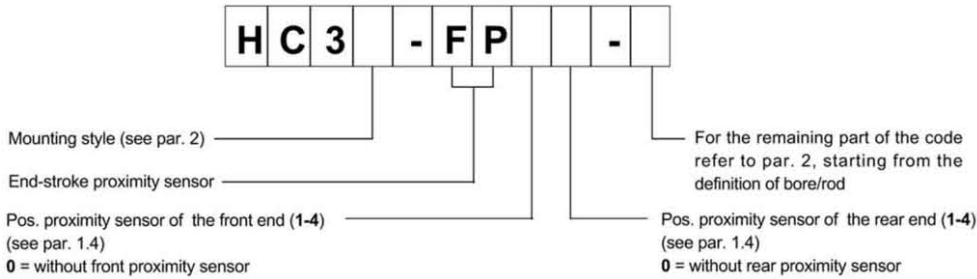

15.2 - Technical characteristics and electrical connection

Rated voltage	Vcc	24
Power supply voltage range	Vcc	10 ÷ 30
Absorbed current	mA	200
Output	normally open contact	
Electric protection	- polarity inversion - short circuit - overvoltage	
Maximum operating pressure	bar	500
Electric connection	with connector	
Operating temperature range	°C	-25 ÷ +80
Class of protection according to IEC 144 standards Atmospheric agents	IP68	
Piston position LEDS	NO (present on connector)	

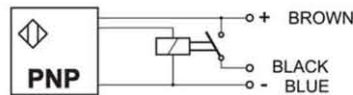

15.3 - Connectors

Connectors for proximity sensors must be ordered separately, by specifying the code: **ECM3S/M12L/10**

Pre-wired connector M12 - IP68 - cable with 3 0,34 mm² conductors
length 5 m. - cable material: POLYURETHANE RESIN (oil resistant)

Leds: - piston at stroke end Yellow led ON - green led ON
 - piston not at stroke end Yellow led OFF - green led ON

NOTE: The green led indicates the presence of power supply voltage to the connector.

supplied connector: Green led ON
 not supplied connector: Green led OFF

16 - OVERALL AND MOUNTING DIMENSIONS

SPHERIC SWIVEL ISO 6982 / DIN 24338

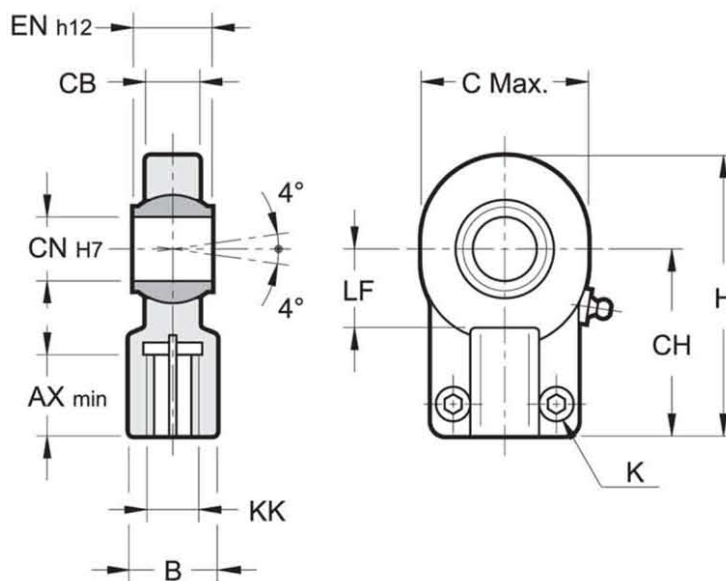

Dimensions in mm

Type	Ø cylinder bore	AX min	B	C max	CB	CH	Ø CN H7	EN h12	H	KK	LF	K BOLT UNI 5931	Torque Nm	Max load kN	Mass kg
LSF-36	50	37	38	76	27	80	32	32	119	M27x2	32	M10x25	49	67	1,17
LSF-45	63	46	47	97	32	97	40	40	146	M33x2	41	M10x30	49	100	2,15
LSF-56	80	57	58	118	40	120	50	50	180	M42x2	50	M12x35	86	156	3,75
LSF-70	100	64	70	142	52	140	63	63	212	M48x2	62	M16x40	210	255	7
LSF-90	125	86	90	180	66	180	80	80	271	M64x3	78	M20x50	410	400	13,8
LSF-100	140	91	100	185	72	195	90	90	296	M72x3	85	M20x60	410	490	19,1
LSF-110	160	96	110	224	84	210	100	100	322	M80x3	98	M24x60	710	610	25
LSF-125	180	106	125	235	88	235	110	110	364	M90x3	105	M24x60	710	655	32
LSF-140	200	113	135	290	102	260	125	125	405	M100x3	120	M24x70	710	950	46
LSF-180	250	126	165	346	130	310	160	160	480	M125x4	150	M24x80	710	1370	82,5
LSF-220	320	161	215	460	162	390	200	200	620	M160x4	195	M30x100	1500	2120	168

HC3

SERIES 10

17 - OVERALL AND MOUNTING DIMENSIONS

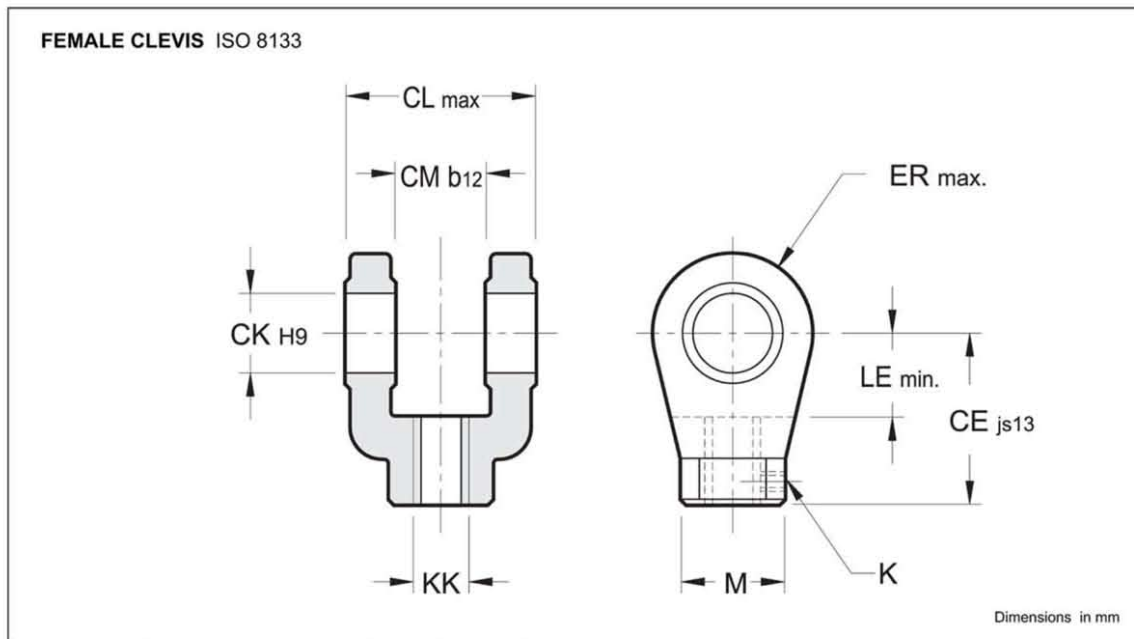

Type	Ø cylinder bore	M	CE	Ø CK	CL	CM	ER	KK	LE	K bolt	Max load	Mass
		CH	js13	H9	max	b12	max		min		kN	kg
FRC-36	50	40	75	28	83	40	34	M27x2	39	M6x6	80	1.8
FRC-45	63	55	99	36	103	50	50	M33x2	54	M8x8	125	3.7
FRC-56	80	56	113	45	123	60	53	M42x2	57	M8x8	200	5.6
FRC-70	100	75	126	56	143	70	59	M48x2	63	M12x12	320	9.3
FRC-90	125	95	168	70	163	80	78	M64x3	83	M12x12	500	20
FRC-110	160	95	168	70	163	80	78	M80x3	83	M12x12	500	20

18 - OVERALL AND MOUNTING DIMENSIONS

