

Part number:

HYDROMA

HYDRAULICKÉ SYSTÉMY

**HIDROMA
SYSTEMS**

UKŁADY HYDRAULICZNE

HYDROMA

ГИДРАВЛИЧЕСКИЕ СИСТЕМЫ

ALP1

COME ORDINARE / HOW TO ORDER

| ALP1 | TIPO TYPE | ROTAZIONE ROTATION | TAGLIA SIZE | ALBERO* SHAFT* | PORTE* PORTS* | GUARNIZIONI* SEALS* | OPZIONI* OPTIONS* | DRENAGGIO DRAIN |
|------|--------------|------------------------------------|----------------|-------------------|------------------|------------------------|----------------------|--------------------|
| | omit | D DESTRA CLOCKWISE | 2 | | | | | |
| | A | S SINISTRA COUNTER CLOCKWISE | 3 | | | | | |
| | | R** REVERSIBILE REVERSIBLE | 4 | | | | | |
| | | | 5 | | | | | |
| | | | 6 | | | | | |
| | | | 7 | | | | | |
| | | | 9 | | | | | |
| | | | 11 | | | | | |
| | | | 13 | | | | | |
| | | | 16 | | | | | |
| | | | 20 | | | | | |

Guarnizioni / Seals
omit (T range = -10°C + 80°C)
V
...

Opzioni / Options
TR
...

**Drenaggio (solo per rotazione R)
Drain (only for R rotation)**
E0 = drenaggio interno / internal drain
*** E1 = drenaggio esterno / external drain G1/4
E2 = drenaggio esterno / external drain 9/16-18 UNF
...

(*) = campi da specificare se diversi dallo standard "tipo pompa" / to be specified if different from standard pump type
(**) = la rotazione reversibile R è disponibile per tutte le taglie indicate / R rotation is available for all listed displacements
(***) = La porta di drenaggio "E2" è lavorata secondo la specifica SAE J1926/1 (ISO 11926-1) relativa a porte filettate con tenuta O-ring. Profondità utile 12,7 mm. / "E2" drain port is machined in compliance with threaded port with O-ring seal in truncated housing SAE J1926/1 (ISO 11926-1). Thread depth 12,7 mm.

Tipi Pompa Standard / Pump Standard Types

omit = flangia europea + albero TO + porte E + guarnizioni standard / european flange + shaft TO+ ports E + standard seals
A = flangia A + albero C1 + porte FA + guarnizioni standard / flange A + shaft C1+ ports FA + standard seals

Esempi / Examples:

ALP1-D-2 = pompa destra, 1,4 cc/rev, flangia europea, albero conico 1:8, porte flangiate tipo E, guarnizioni standard
clockwise rotation, 1,4 cc/rev, european flange, 1:8 tapered shaft, flanged ports E type, standard seals
ALP1-D-2-FG-V = pompa destra, 1,4 cc/rev, flangia europea, albero conico 1:8, porte GAS (FG), guarnizioni per alta temperatura (V)
clockwise rotation, 1,4 cc/rev, european flange, 1:8 tapered shaft, threaded ports (FG), high temperature seals (V)
ALP1A-D-2-S1 = pompa destra, 1,4 cc/rev, flangia SAE A-A 2 fori, albero scanalato 9T (S1), porte filettate, guarnizioni standard
clockwise rotation, 1,4 cc/rev, SAE A-A 2 bolt flange, 9T splined shaft (S1), threaded ports, standard seals
ALP1-R-2-E1 = pompa reversibile, 1,4 cc/rev, flangia europea, albero conico 1:8, porte flangiate tipo E, guarnizioni standard, drenaggio esterno
reversible pump, 1,4 cc/rev, european flange, 1:8 tapered shaft, flanged ports E type, standard seals, external drain

LE TAVOLE DI PRODOTTO RAPPRESENTANO I TIPI POMPA STANDARD PER MARZOCCHI POMPE. LE TAVOLE SINOTTICHE DI FLANGE, ALBERI E PORTE HANNO LO SCOPO DI RAPPRESENTARE TUTTE LE POSSIBILI CONFIGURAZIONI DI PRODOTTO. PER MAGGIORI DETTAGLI SULLE DISPONIBILITÀ E CONDIZIONI DI FORNITURA, CONSIGLIAMO DI INTERPELLARE IL NOSTRO UFFICIO TECNICO-COMMERCIALE.

THE PRODUCT DATA SHEETS SHOW OUR STANDARD MODEL TYPES. THE SYNOPTIC TABLES FOR FLANGES, SHAFTS AND PORTS SHOW ALL THE POSSIBLE CONFIGURATIONS. FOR FURTHER DETAILS ABOUT THE AVAILABILITY OF EACH CONFIGURATION PLEASE CONTACT OUR SALES AND TECHNICAL DEPT.

ALP1

Parti accessorie a corredo della pompa standard: linguetta a disco (codice 522054), dado M10x1 (codice 523015), rosetta elastica spaccata (codice 523004).
 Parte standard: filetti M6 profondità utile 13 mm.

Accessories supplied with the standard pump: woodruff key (code 522054), M10x1 exagonal nut (code 523015), washer (code 523004).
 Standard parts: M6 threads depth 13 mm.

MANDATA
OUTLET

ASPIRAZIONE
INLET

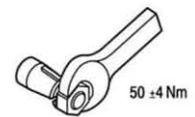
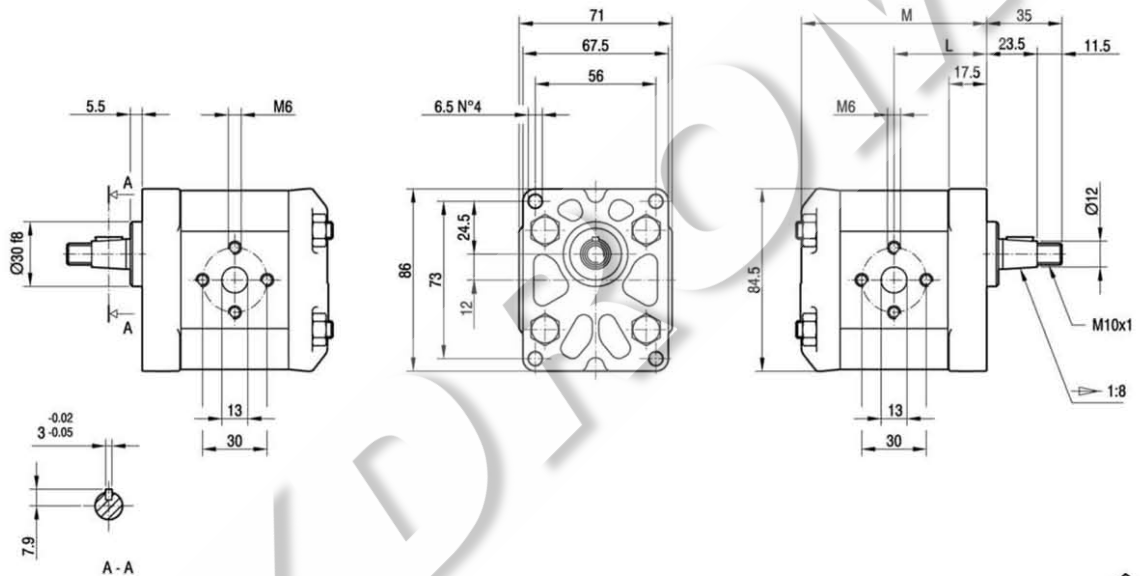

| TIPO TYPE | CILINDRATA DISPLACEMENT | PORTATA a 1500 giri/min FLOW at 1500 rev/min | PRESSIONI MASSIME MAX PRESSURE | | | VELOCITÀ MASSIMA MAX SPEED | DIMENSIONI DIMENSIONS | |
|--------------|--|---|-----------------------------------|----------------|----------------|-------------------------------|--------------------------|-------|
| | | | P ₁ | P ₂ | P ₃ | | L | M |
| | cm ³ /giro [cm ³ /rev] | litri/min [litres/min] | bar | bar | bar | giri/min [rpm] | mm | mm |
| ALP1-D-2 | 1,4 | 2,0 | 250 | 270 | 290 | 6000 | 40 | 80,5 |
| ALP1-D-3 | 2,1 | 2,9 | 250 | 270 | 290 | 6000 | 41 | 82,5 |
| ALP1-D-4 | 2,8 | 3,9 | 250 | 270 | 290 | 5000 | 42 | 84,5 |
| ALP1-D-5 | 3,5 | 4,9 | 250 | 270 | 290 | 5000 | 43 | 86,5 |
| ALP1-D-6 | 4,1 | 5,9 | 250 | 270 | 290 | 4000 | 44 | 88,5 |
| ALP1-D-7 | 5,2 | 7,4 | 230 | 245 | 260 | 4000 | 45,5 | 91,5 |
| ALP1-D-9 | 6,2 | 8,8 | 230 | 245 | 260 | 3800 | 47 | 94,5 |
| ALP1-D-11 | 7,6 | 10,8 | 200 | 215 | 230 | 3200 | 49 | 98,5 |
| ALP1-D-13 | 9,3 | 13,3 | 180 | 195 | 210 | 2600 | 51,5 | 103,5 |
| ALP1-D-16 | 11,0 | 15,7 | 170 | 185 | 200 | 2200 | 54 | 108,5 |
| ALP1-D-20 | 13,8 | 19,7 | 150 | 165 | 180 | 1800 | 58 | 116,5 |

ALPIA

Parti accessorie a corredo della pompa standard: linguetta (codice 522070).
Monta flangia 50-2 (A-A) secondo norma SAE J744c.

Le porte standard "D" e "d" sono lavorate secondo la specifica SAE J1926/1 (ISO 11926-1) relativa a porte filettate con tenuta O-ring.

Accessories supplied with the standard pump: key (code 522070).

Mounting flange 50-2 (A-A) in compliance with SAE J744c.

"D" and "d" standard parts are machined in compliance with threaded port with O-ring seal in truncated housing SAE J1926/1 (ISO 11926-1).

MANDATA
OUTLET

ASPIRAZIONE
INLET

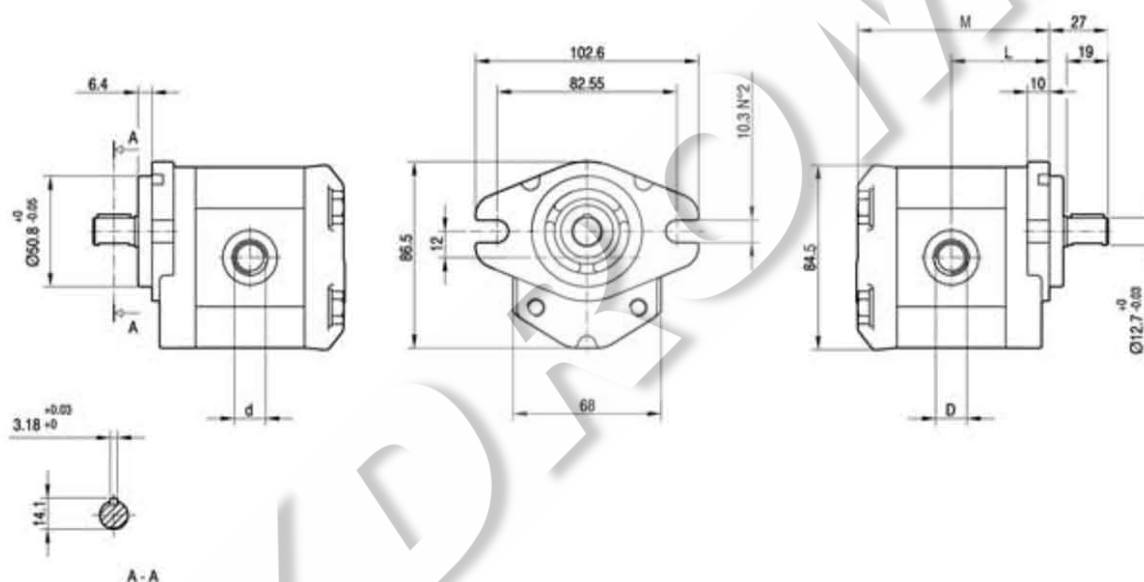

| TIPO TYPE | CILINDRATA DISPLACEMENT | PORTATA a 1500 giri/min FLOW at 1500 rev/min | PRESSIONI MASSIME MAX PRESSURE | | | VELOCITÀ MASSIMA MAX SPEED | DIMENSIONI DIMENSIONS | | | |
|--------------|--|---|-----------------------------------|----------------|----------------|-------------------------------|--------------------------|-------|-------------|------------|
| | | | P ₁ | P ₂ | P ₃ | | L | M | d | D |
| | cm ³ /giri [cm ³ /rev] | litri/min [litres/min] | bar | bar | bar | giri/min [rpm] | mm | mm | | |
| ALPIA-D2 | 1,4 | 2,0 | 250 | 270 | 290 | 6000 | 42 | 82,5 | 9/16-18 UNF | 3/4-16 UNF |
| ALPIA-D3 | 2,1 | 2,9 | 250 | 270 | 290 | 6000 | 43 | 84,5 | 9/16-18 UNF | 3/4-16 UNF |
| ALPIA-D4 | 2,8 | 3,9 | 250 | 270 | 290 | 5000 | 44 | 86,5 | 9/16-18 UNF | 3/4-16 UNF |
| ALPIA-D5 | 3,5 | 4,9 | 250 | 270 | 290 | 5000 | 45 | 88,5 | 9/16-18 UNF | 3/4-16 UNF |
| ALPIA-D6 | 4,1 | 5,9 | 250 | 270 | 290 | 4000 | 46 | 90,5 | 9/16-18 UNF | 3/4-16 UNF |
| ALPIA-D7 | 5,2 | 7,4 | 230 | 245 | 260 | 3500 | 47,5 | 93,5 | 9/16-18 UNF | 3/4-16 UNF |
| ALPIA-D9 | 6,2 | 8,8 | 230 | 245 | 260 | 3000 | 49 | 96,5 | 9/16-18 UNF | 3/4-16 UNF |
| ALPIA-D11 | 7,6 | 10,8 | 200 | 215 | 230 | 3500 | 51 | 100,5 | 3/4-16 UNF | 7/8-14 UNF |
| ALPIA-D13 | 9,3 | 13,3 | 180 | 195 | 210 | 3000 | 53,5 | 105,5 | 3/4-16 UNF | 7/8-14 UNF |
| ALPIA-D16 | 11,0 | 15,7 | 170 | 185 | 200 | 2500 | 56 | 110,5 | 3/4-16 UNF | 7/8-14 UNF |
| ALPIA-D20 | 13,8 | 19,7 | 150 | 165 | 180 | 2000 | 60 | 118,5 | 3/4-16 UNF | 7/8-14 UNF |

ALP1

FLANGE / FLANGES

ALBERI / SHAFTS

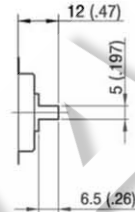
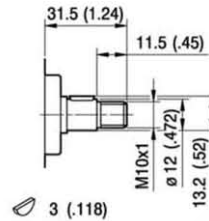
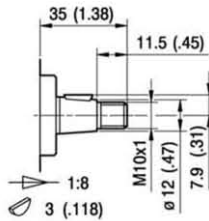
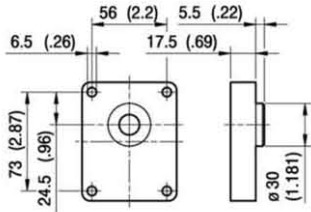

TO

Coppia Max
Max Torque 100 Nm

C0

Coppia Max
Max Torque 55 Nm

G0

Coppia Max
Max Torque 45 Nm

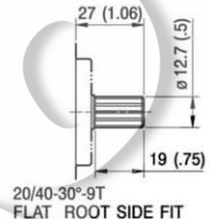
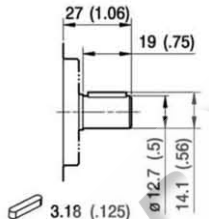
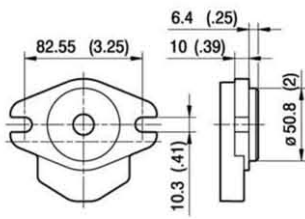

20/40-30°-9T
FLAT ROOT SIDE FIT

C1

Coppia Max
Max Torque 60 Nm

S1

Coppia Max
Max Torque 100 Nm

ALP1

PORTE / PORTS

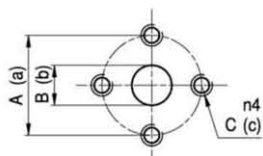

| TIPO TYPE | ASPIRAZIONE INLET | | | MANDATA OUTLET | | |
|----------------------|----------------------|----|----|-------------------|----|----|
| | A | B | C | a | b | c |
| ALP1...2 ÷ ALP1...20 | 30 | 13 | M6 | 30 | 13 | M6 |

I valori delle coppie di serraggio delle viti presenti nel kit raccordo sono indicate a pag 57 (capitolo accessori).
Tightening torques of the fittings screws are specified on page 57 (accessories section).

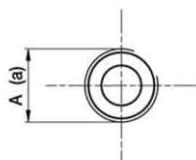

| TIPO TYPE | ASPIRAZIONE INLET | MANDATA OUTLET |
|----------------------|----------------------|-------------------|
| | A | a |
| ALP1...2 ÷ ALP1...5 | G1/2 | G3/8 |
| ALP1...6 ÷ ALP1...20 | G1/2 | G1/2 |

Raccordo G1/2 coppia di serraggio massima 50 Nm. Raccordo G3/8 coppia di serraggio massima 35 Nm.
Consigliamo di richiedere conferma al fornitore del raccordo.
Tightening torques for G1/2 fitting: 50 Nm. Tightening torques for G3/8 fitting: 35 Nm. Please check with the fittings suppliers.

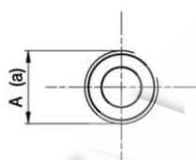

| TIPO TYPE | ASPIRAZIONE INLET | MANDATA OUTLET |
|----------------------|----------------------|-------------------|
| | A | a |
| ALP1...2 ÷ ALP1...20 | Rc1/2 | Rc1/2 |

Raccordo Rc1/2 coppia di serraggio massima 50 Nm.
Consigliamo di richiedere conferma al fornitore del raccordo.
Tightening torques for Rc1/2 fitting: 50 Nm. Please check with the fittings suppliers.

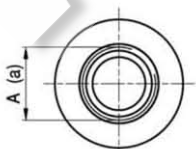

STANDARD SAE J1926/1

| TIPO TYPE | ASPIRAZIONE INLET | MANDATA OUTLET |
|-----------------------|----------------------|-------------------|
| | A | a |
| ALP1...2 ÷ ALP1...9 | 3/4-16 UNF | 9/16-18 UNF |
| ALP1...11 ÷ ALP1...20 | 7/8-14 UNF | 3/4-16 UNF |

Raccordo 9/16-18 UNF coppia di serraggio massima 30 Nm. Raccordo 3/4-16 UNF coppia di serraggio massima 60 Nm.
Raccordo 7/8-14 UNF coppia di serraggio massima 70 Nm. Consigliamo di richiedere conferma al fornitore del raccordo.
Tightening torques for 9/16-18 UNF fitting: 30 Nm. Tightening torques for 3/4-16 UNF fitting: 60 Nm.
Tightening torques for 7/8-14 UNF fitting: 70 Nm. Please check with the fittings suppliers.

Potenza assorbita Absorbed power P [kW]
 Momento torcente assorbito Absorbed torque M [Nm]
 Velocità di rotazione Drive speed n [giri/min] [rpm]

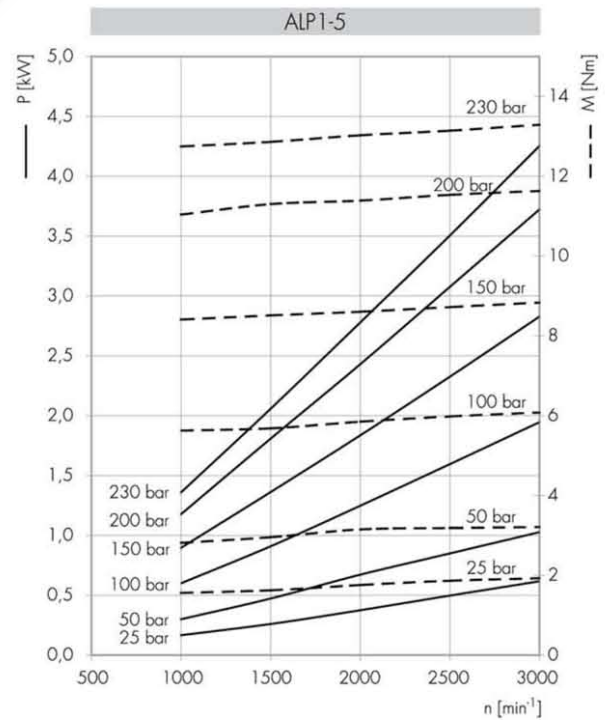
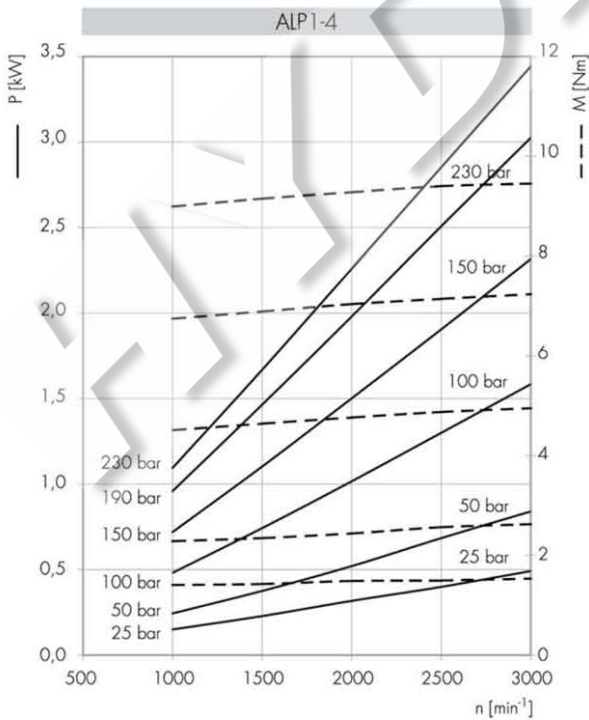
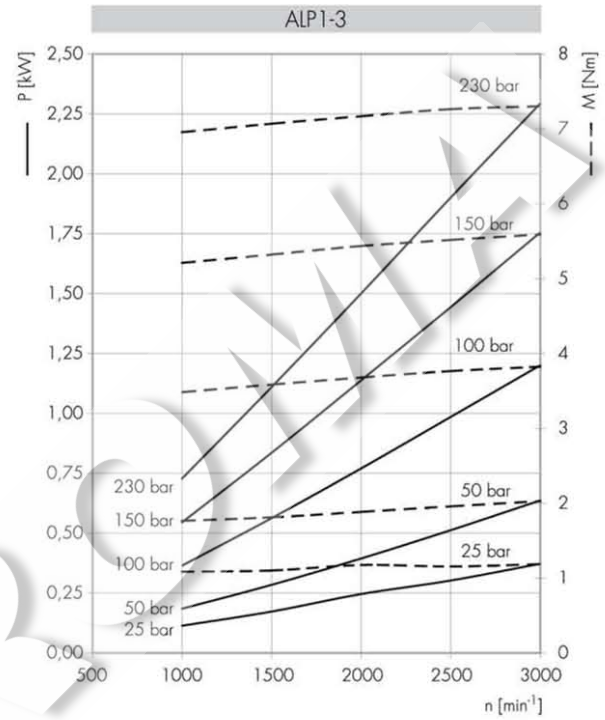
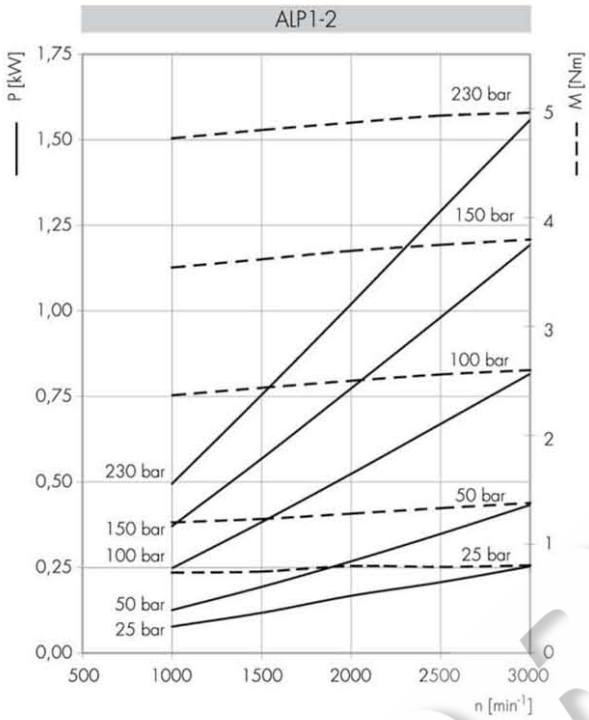

Potenza assorbita Absorbed power P [kW]
 Momento torcente assorbito Absorbed torque M [Nm]
 Velocità di rotazione Drive speed n [giri/min] [rpm]

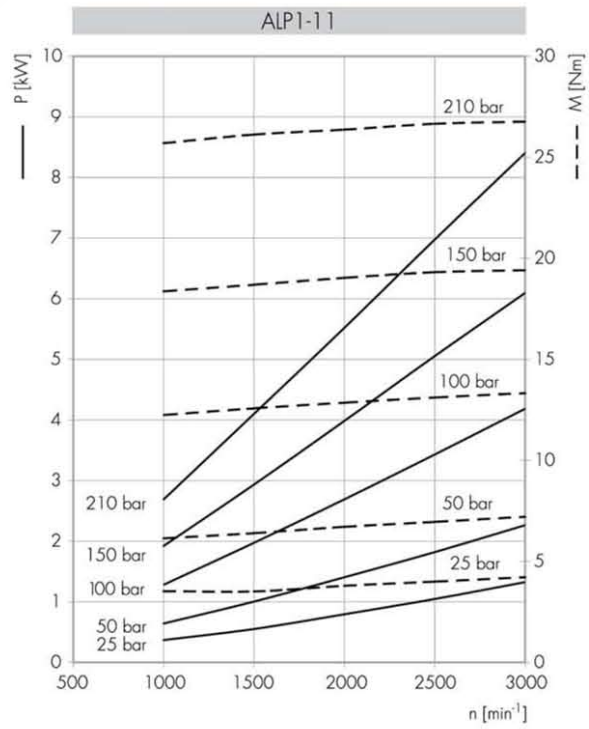
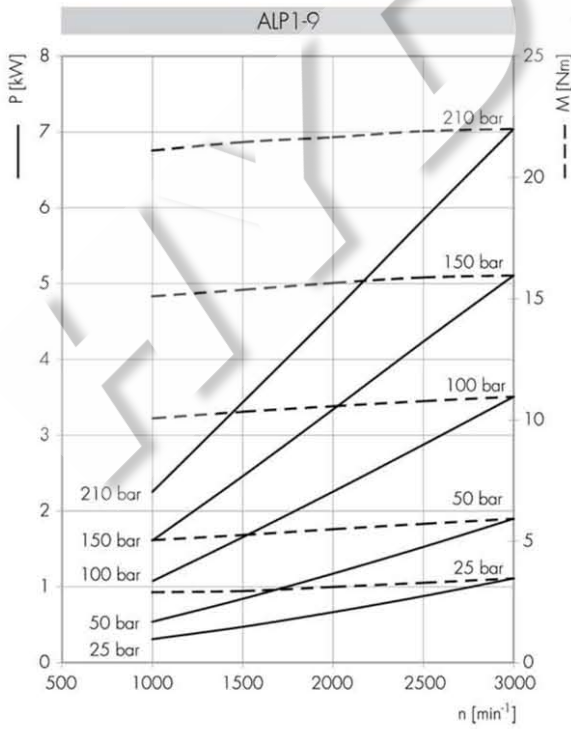
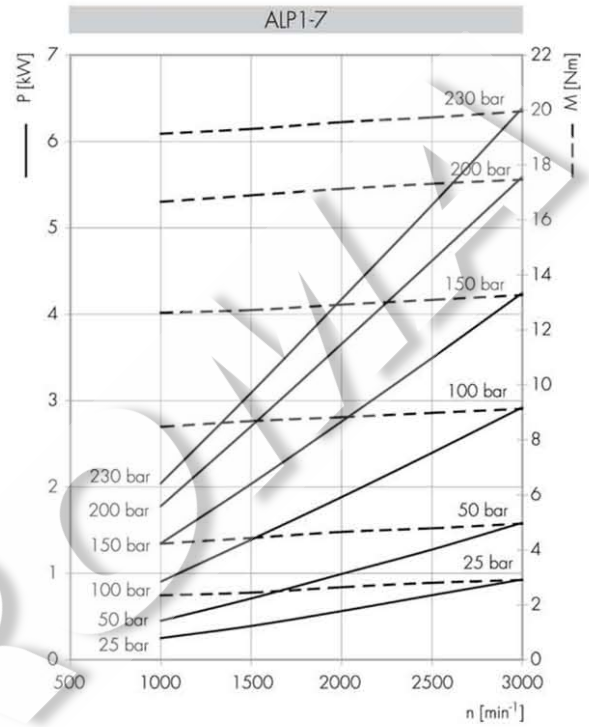
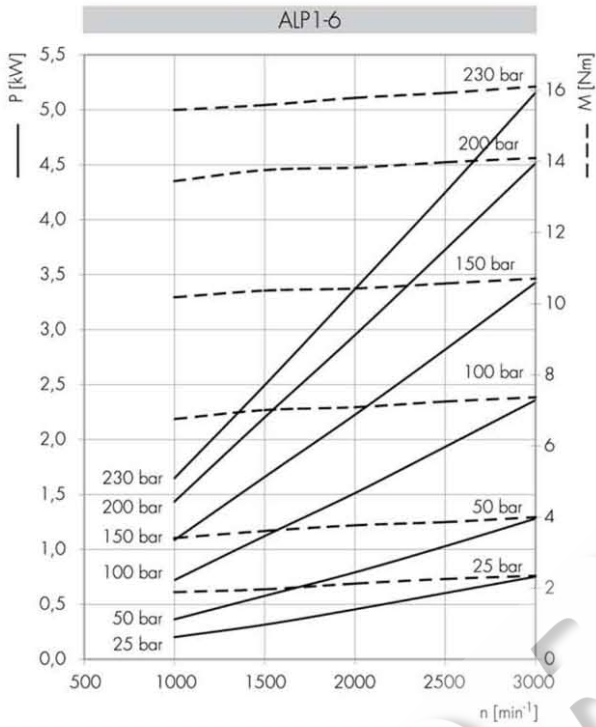

Potenza assorbita Absorbed power P [kW]
 Momento torcente assorbito Absorbed torque M [Nm]
 Velocità di rotazione Drive speed n [giri/min] [rpm]

