

Part number:

127-10591**HYDROMA**

HYDRAULICKÉ SYSTÉMY

**HIDROMA
SISTEMS**

UKŁADY HYDRAULICZNE

HYDROMA

ГИДРАВЛИЧЕСКИЕ СИСТЕМЫ

DKOL

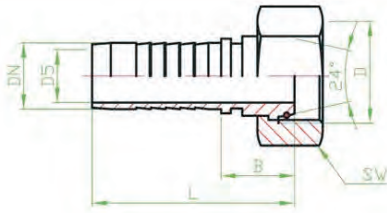

Koncovka s převlečnou maticí a těsnící kuželkou pro těsnící kužel 24° s těsnícím O-kroužkem, s rozměry těsnícího kužele a závitu v lehké řadě
Coupling with a tapered nipple and a cup nut with O-ring, mating with 24° flares, light series

Světlost Hose bore		Závit Thread D	Rozměry mm Dimensions mm				Ozn. přípoje Connection marking
DN	in		D5	SW	B	L	
6	1/4"	M12x1,5	2,8	14	27	53	DKOL M12x1,5
6	1/4"	M14x1,5	3,6	17	22	49	DKOL
6	1/4"	M16x1,5	4	19	23	50	DKOL M16x1,5
8	5/16"	M14x1,5	4	17	26	54	DKOL M14x1,5
8	5/16"	M16x1,5	5,2	19	23	50	DKOL
8	5/16"	M18x1,5	5,5	22	23	50	DKOL M18x1,5
10	3/8"	M16x1,5	5,5	19	28	58	DKOL M16x1,5
10	3/8"	M18x1,5	6,4	22	24	54	DKOL
10	3/8"	M22x1,5	7	27	26	56	DKOL M22x1,5
12	1/2"	M18x1,5	7	22	31	62	DKOL M18x1,5
12	1/2"	M22x1,5	9,4	27	25	56	DKOL
12	1/2"	M26x1,5	10	32	28	59	DKOL M26x1,5
16	5/8"	M22x1,5	10	27	30	64	DKOL M22x1,5
16	5/8"	M26x1,5	12	32	26	62	DKOL
16	5/8"	M27x1,5	12	32	29	63	DKOL M27x1,5
16	5/8"	M27x2	12	32	29	63	DKOL M27x2
16	5/8"	M30x2	12,6	36	26	63	DKOL M30x2
19 (20)	3/4"	M26x1,5	11	32	32	71	DKOL M26x1,5
19 (20)	3/4"	M30x2	15	36	30	69	DKOL
19 (20)	3/4"	M36x2	14,8	41	33	71	DKOL M36x2
25	1"	M30x2	14	36	37	84	DKOL M30x2
25	1"	M36x2	20	41	32	79	DKOL
25	1"	M45x2	21	50	37	84	DKOL M45x2
31 (32)	1 1/4"	M36x2	26,5	41	47	91	DKOL M36x2
31 (32)	1 1/4"	M45x2	26	50	36	90	DKOL
38 (40)	1 1/2"	M45x2	27	50	41	98	DKOL
38 (40)	1 1/2"	M52x2	32	60	38	95	DKOL

DKOL 45°

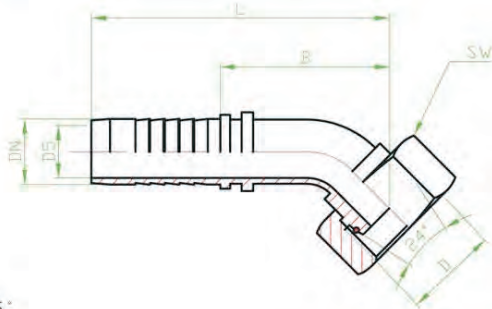

Koleno 45°
Elbow 45°

Světlost Hose bore		Závit Thread D	Rozměry mm Dimensions mm				Ozn. přípoje Connection marking
DN	in		D5	SW	B	L	
6	1/4"	M12x1,5	2,8	14	40	67	DKOL 45° M12x1,5
6	1/4"	M14x1,5	3,6	17	41	68	DKOL 45°
6	1/4"	M16x1,5	4	19	34	62	DKOL 45° M16x1,5
8	5/16"	M14x1,5	4	17	44	71	DKOL 45° M14x1,5
8	5/16"	M16x1,5	5,2	19	45	72	DKOL 45°
8	5/16"	M18x1,5	5,5	22	45	72	DKOL 45° M18x1,5
10	3/8"	M16x1,5	5,5	19	44	74	DKOL 45° M16x1,5
10	3/8"	M18x1,5	6,4	22	44	74	DKOL 45°
10	3/8"	M22x1,5	7	27	36	66	DKOL 45° M22x1,5
12	1/2"	M18x1,5	7	22	52	83	DKOL 45° M18x1,5
12	1/2"	M22x1,5	9,4	27	58	90	DKOL 45°
12	1/2"	M26x1,5	10	32	50	81	DKOL 45° M26x1,5
16	5/8"	M22x1,5	10	27	69	103	DKOL 45° M22x1,5
16	5/8"	M26x1,5	12	32	68	102	DKOL 45°
16	5/8"	M27x1,5	12	32	68	102	DKOL 45° M27x1,5
16	5/8"	M27x2	12	32	68	102	DKOL 45° M27x2
16	5/8"	M30x2	12,6	36	68	102	DKOL 45° M30x2
19 (20)	3/4"	M26x1,5	11	32	81	120	DKOL 45° M26x1,5
19 (20)	3/4"	M30x2	15	36	80	119	DKOL 45°
19 (20)	3/4"	M36x2	14,8	41	81	120	DKOL 45° M36x2
25	1"	M30x2	14	36	83	129	DKOL 45° M30x2
25	1"	M36x2	20	41	82	128	DKOL 45°
25	1"	M45x2	21	50	83	129	DKOL 45° M45x2
31 (32)	1 1/4"	M36x2	26,5	41	116	169	DKOL 45° M36x2
31 (32)	1 1/4"	M45x2	26	50	115	163	DKOL 45°
38 (40)	1 1/2"	M45x2	27	50	112	170	DKOL
38 (40)	1 1/2"	M52x2	32	60	113	171	DKOL

DKOL 90°

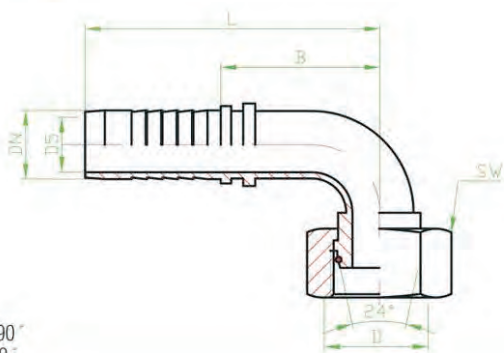

Koleno 90°
Elbow 90°

Světlost Hose bore DN	Závit Thread in D	Rozměry mm Dimensions mm				Ozn. přípoje Connection marking	
		D5	SW	B	L		
6	1/4"	M12x1,5	2,8	14	26	53	DKOL 90° M12x1,5
6	1/4"	M14x1,5	3,6	17	26	53	DKOL 90°
6	1/4"	M16x1,5	4	19	26	53	DKOL 90° M16x1,5
8	5/16"	M14x1,5	4	17	30	57	DKOL 90° M14x1,5
8	5/16"	M16x1,5	5,2	19	30	57	DKOL 90°
8	5/16"	M18x1,5	5,5	22	30	57	DKOL 90° M18x1,5
10	3/8"	M16x1,5	5,5	19	30	60	DKOL 90° M16x1,5
10	3/8"	M18x1,5	6,4	22	30	60	DKOL 90°
10	3/8"	M22x1,5	7	27	30	60	DKOL 90° M22x1,5
12	1/2"	M18x1,5	7	22	42	73	DKOL 90° M18x1,5
12	1/2"	M22x1,5	9,4	27	42	73	DKOL 90°
12	1/2"	M26x1,5	10	32	42	73	DKOL 90° M26x1,5
16	5/8"	M22x1,5	10	27	52	86	DKOL 90° M22x1,5
16	5/8"	M26x1,5	12	32	52	86	DKOL 90°
16	5/8"	M27x1,5	12	32	52	86	DKOL 90° M27x1,5
16	5/8"	M27x2	12	32	52	86	DKOL 90° M27x2
16	5/8"	M30x2	12,6	36	52	86	DKOL 90° M30x2
19 (20)	3/4"	M26x1,5	11	32	60	99	DKOL 90° M26x1,5
19 (20)	3/4"	M30x2	15	36	60	99	DKOL 90°
19 (20)	3/4"	M36x2	14,8	41	60	99	DKOL 90° M36x2
25	1"	M30x2	14	36	65	111	DKOL 90° M30x2
25	1"	M36x2	20	41	65	111	DKOL 90°
25	1"	M45x2	21	50	65	111	DKOL 90° M45x2
31 (32)	1 1/4"	M36x2	26,5	41	94	148	DKOL 90° M36x2
31 (32)	1 1/4"	M45x2	26	50	94	148	DKOL 90°
38 (40)	1 1/2"	M45x2	27	50	105	162	DKOL 90°
38 (40)	1 1/2"	M52x2	32	60	105	162	DKOL 90°

DKOS

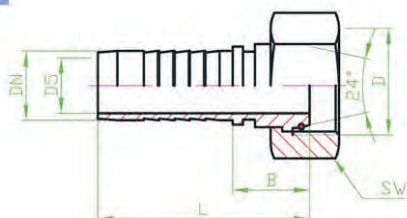

Koncovka s převlečnou maticí a těsnící kuželkou pro těsnící kužel 24° s těsnícím O-kroužkem, s rozměry těsnícího kužele a závitů v těžké řadě
Coupling with a tapered nipple and a cup nut with O-ring, mating with 24° flares, heavy series

Světlost Hose bore DN	Závit Thread in D	Rozměry mm Dimensions mm				Ozn. přípoje Connection marking	
		D5	SW	B	L		
6	1/4"	M16x1,5	4	19	25	52	DKOS M16x1,5
6	1/4"	M18x1,5	4	22	25	52	DKOS M18x1,5
8	5/16"	M18x1,5	5,5	22	29	52	DKOS M18x1,5
8	5/16"	M20x1,5	5,5	24	24	52	DKOS M20x1,5
8	5/16"	M22x1,5	5,5	27	29	52	DKOS M22x1,5
10	3/8"	M20x1,5	7	24	26	26	DKOS M20x1,5
10	3/8"	M22x1,5	7	27	27	56	DKOS M22x1,5
12	1/2"	M22x1,5	7	27	32	63	DKOS M22x1,5
12	1/2"	M24x1,5	10	30	29	60	DKOS M24x1,5
12	1/2"	M30x2	10	36	32	64	DKOS M30x2
16	5/8"	M24x1,5	10	30	32	67	DKOS M24x1,5
16	5/8"	M30x2	13	36	36	69	DKOS M30x2
16	5/8"	M36x2	12,6	46	34	68	DKOS M36x2
19 (20)	3/4"	M30x2	11	36	37	76	DKOS M30x2
19 (20)	3/4"	M36x2	15	46	39,5	86	DKOS M36x2
19 (20)	3/4"	M42x2	14,8	50	34	73	DKOS M42x2
25	1"	M36x2	14	46	40	87	DKOS M36x2
25	1"	M42x2	20	50	34,5	93	DKOS M42x2
25	1"	M52x2	21	60	37	84	DKOS M52x2
31 (32)	1 1/4"	M42x2	26,5	50	41	95	DKOS M42x2
31 (32)	1 1/4"	M52x2	26	60	38,5	101,5	DKOS M52x2
38 (40)	1 1/2"	M52x2	27	60	41	99	DKOS M52x2

Do objednávky uvádějte světlost hadice a označení přípoje.
Mention hose bore and connection marking in each order.
Rozměry jsou pouze informativní.
Dimensions have only informative character.

SFS 90°



Koleno 90°
Elbow 90°

Světlost Hose bore DN	Příruba Flange in	Rozměry mm Dimensions mm	O-kr. O-ring		Ozn. přípoje Connection marking			
			D	D5				
12	1/2"	1/2"	31,75	10	42	73	18,64x3,53	SFS 90°
16	5/8"	3/4"	41,3	12,6	52	86	24,99x3,53	SFS 90°
19 (20)	3/4"	3/4"	41,3	14,8	60	99	24,99x3,53	SFS 90°
25	1"	1"	47,6	20,5	65	111	32,92x3,53	SFS 90°
31 (32)	1 1/4"	1 1/4"	54	26,5	94	148	37,69x3,53	SFS 90°
38 (40)	1 1/2"	1 1/2"	54	32	105	162	37,69x3,53	SFS 90°
38 (40)	1 1/2"	1 1/2"	63,5	32	105	162	47,20x3,53	SFS 90°
38 (40)	2"	2"	79,4	32	105	162	56,70x3,53	SFS 90°

AGN

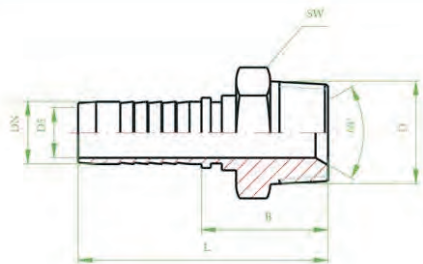

Vnější závit NPTF, úhel 60°
NPTF MALE 60° CONE

Světlost Hose bore DN	Závit Thread in	Rozměry mm Dimensions mm	Ozn. přípoje Connection marking				
			D	SW	D5	B	
6	1/4"	1/4"NPTF	17	4	27	55	AGN
8	5/16"	3/8"NPTF	19	6	27	55	AGN
10	3/8"	3/8"NPTF	19	7	27	57	AGN
12	1/2"	1/2"NPTF	22	10	32	64	AGN
16	5/8"	5/8"NPTF	27	13	34	68	AGN
19 (20)	3/4"	3/4"NPTF	27	15	35	74	AGN
25	1"	1" NPTF	36	21	47	93	AGN
31 (32)	1 1/4"	1 1/4"NPTF	42	27	50	105	AGN
38 (40)	1 1/2"	1 1/2"NPTF	50	32	50	120	AGN

AGR-K

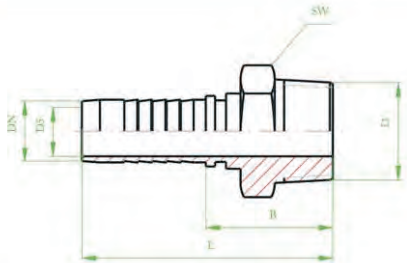

Kuželový Vnější závit BSP
BSP TAPER MALE

Světlost Hose bore DN	Závit Thread in	Rozměry mm Dimensions mm	Ozn. přípoje Connection marking				
			D	SW	D5	B	
6	1/4"	1/4"	17	4	23	50	AGR-K
8	5/16"	3/8"	22	6	25	52	AGR-K
10	3/8"	3/8"	22	7	24	54	AGR-K
12	1/2"	1/2"	27	10	30	61	AGR-K
16	5/8"	5/8"	30	13	29	61	AGR-K
19 (20)	3/4"	3/4"	32	15	30	69	AGR-K
25	1"	1"	38	21	32	78	AGR-K
31 (32)	1 1/4"	1 1/4"	50	27	37	91	AGR-K
38 (40)	1 1/2"	1 1/2"	50	32	49	119	AGR-K

DKR-FLD

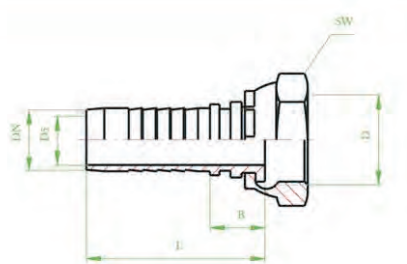

Vnitřní závit BSP
BSP FEMALE FLAT FACE

Světlost Hose bore DN	Závit Thread in	Rozměry mm Dimensions mm	Ozn. přípoje Connection marking				
			D	SW	D5	B	
6	1/4"	1/4"	17	4	23	50	DKR-FLD
8	5/16"	3/8"	22	6	25	52	DKR-FLD
10	3/8"	3/8"	22	7	24	54	DKR-FLD
12	1/2"	1/2"	27	10	30	61	DKR-FLD
16	5/8"	5/8"	30	13	29	61	DKR-FLD
19 (20)	3/4"	3/4"	32	15	30	69	DKR-FLD
25	1"	1"	38	21	32	78	DKR-FLD
31 (32)	1 1/4"	1 1/4"	50	27	37	91	DKR-FLD

Do objednávky uvádějte světlost hadice a označení přípoje.
Mention hose bore and connection marking in each order.
Rozměry jsou pouze informativní.
Dimensions have only informative character.

AGR

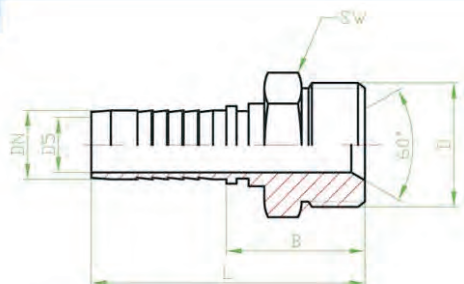

Vnější závit BSP vnitřní úhel 60°
Male nipple, BSP inner angle, 60° cone

Světlost Hose bore DN	Závit Thread		Rozměry mm Dimensions mm				Ozn. přípoje Connection marking
	in	D	D5	SW	B	L	
6	1/4"	1/4"	4	19	25,7	53	AGR 1/4"
6	1/4"	3/8"	4	22	27,2	54,5	AGR 3/8"
8	5/16"	3/8"	5,5	22	28	56,5	AGR 3/8"
10	3/8"	3/8"	7	22	28	56,5	AGR 3/8"
10	3/8"	1/2"	7	27	31	59,5	AGR 1/2"
12	1/2"	1/2"	10	27	31,5	61,5	AGR 1/2"
16	5/8"	5/8"	12,5	30	33,5	66,5	AGR 5/8"
16	5/8"	3/4"	12,5	32	34,5	67,5	AGR 3/4"
19 (20)	3/4"	3/4"	15,5	32	35,5	74,5	AGR 3/4"
19 (20)	3/4"	1"	15,5	41	39,5	78,5	AGR 1"
25	1"	1"	20	41	40	92,5	AGR 1"
25	1"	1 1/4"	20	50	44	96,5	AGR 1 1/4"
31 (32)	1 1/4"	1 1/4"	26	50	45,5	105,5	AGR 1 1/4"
31 (32)	1 1/4"	1 1/2"	26	55	47,5	107,5	AGR 1 1/2"
38 (40)	1 1/2"	1 1/2"	32	55	47,5	117,5	AGR 1 1/2"

DKR

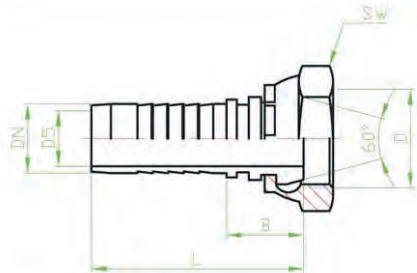

Vnitřní závit BSP – kužel 60°
Female nipple, BSP cylindrical, 60° cone

Světlost Hose bore DN	Závit Thread		Rozměry mm Dimensions mm				Ozn. přípoje Connection marking
	in	D	D5	SW	B	L	
6	1/4"	1/4"	4	19	16,7	49	DKR 1/4"
6	1/4"	3/8"	4	22	18,7	52	DKR 3/8"
8	5/16"	3/8"	5,5	22	20	54,5	DKR 3/8"
10	3/8"	3/8"	7	22	20	54,5	DKR 3/8"
10	3/8"	1/2"	7	27	22	56,5	DKR 1/2"
12	1/2"	1/2"	10	27	22,5	58,5	DKR 1/2"
16	5/8"	5/8"	12,5	30	24	63,5	DKR 5/8"
16	5/8"	3/4"	12,5	32	24	64,5	DKR 3/4"
19 (20)	3/4"	3/4"	15,5	32	25,5	72	DKR 3/4"
19 (20)	3/4"	1"	15,5	41	26	75	DKR 1"
25	1"	1"	20	41	26,5	89	DKR 1"
25	1"	1 1/4"	20	50	32,5	96,5	DKR 1 1/4"
31 (32)	1 1/4"	1 1/4"	26	50	33	102,5	DKR 1 1/4"
31 (32)	1 1/4"	1 1/2"	26	55	35	106	DKR 1 1/2"
38 (40)	1 1/2"	1 1/2"	32	55	35	116	DKR 1 1/2"

DKR 45°

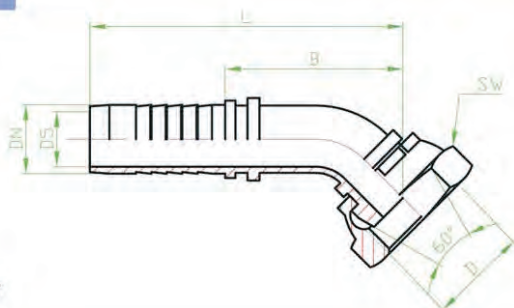

Koleno 45°
Elbow 45°

Světlost Hose bore DN	Závit Thread		Rozměry mm Dimensions mm				Ozn. přípoje Connection marking
	in	D	D5	SW	B	L	
6	1/4"	1/4"	4	19	37,5	65	DKR 45° 1/4"
6	1/4"	3/8"	4	22	39,5	67	DKR 45° 3/8"
8	5/16"	3/8"	5,5	22	44	72,5	DKR 45° 3/8"
10	3/8"	3/8"	7	22	50	78,5	DKR 45° 3/8"
10	3/8"	1/2"	7	27	52	80,5	DKR 45° 1/2"
12	1/2"	1/2"	10	27	62	92	DKR 45° 1/2"
16	5/8"	5/8"	12,5	30	72,5	105,5	DKR 45° 5/8"
16	5/8"	3/4"	12,5	32	72,5	105,5	DKR 45° 3/4"
19 (20)	3/4"	3/4"	15,5	32	64	103	DKR 45° 3/4"
19 (20)	3/4"	1"	15,5	41	65,5	104,5	DKR 45° 1"
25	1"	1"	20	41	85	137,5	DKR 45° 1"
25	1"	1 1/4"	20	50	90,5	143	DKR 45° 1 1/4"
31 (32)	1 1/4"	1 1/4"	26	50	99,5	159,5	DKR 45° 1 1/4"
38 (40)	1 1/2"	1 1/2"	32	55	112	182	DKR 45° 1 1/2"

Do objednávky uvádějte světlost hadice a označení přípoje.
Mention hose bore and connection marking in each order.
Rozměry jsou pouze informativní.
Dimensions have only informative character.

DKR 90°

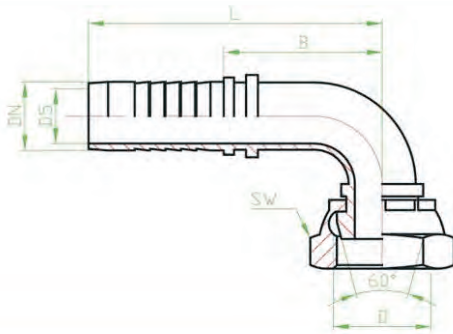
Koleno 90°
Elbow 90°

Světlost Hose bore DN	Závit Thread in D	Rozměry mm Dimensions mm				Ozn. přípoje Connection marking	
		D5	SW	B	L		
6	1/4"	1/4"	4	19	23	50,5	DKR 90° 1/4"
6	1/4"	3/8"	4	22	23	50,5	DKR 90° 3/8"
8	5/16"	3/8"	5,5	22	26	54,5	DKR 90° 3/8"
10	3/8"	3/8"	7	22	30,5	59	DKR 90° 3/8"
10	3/8"	1/2"	7	27	30,5	59	DKR 90° 1/2"
12	1/2"	1/2"	10	27	38	68	DKR 90° 1/2"
16	5/8"	5/8"	12,5	30	44,5	77,5	DKR 90° 5/8"
16	5/8"	3/4"	12,5	32	44,5	77,5	DKR 90° 3/4"
19 (20)	3/4"	3/4"	15,5	32	54	93	DKR 90° 3/4"
19 (20)	3/4"	1"	15,5	41	54	93	DKR 90° 1"
25	1"	1"	20	41	74	126,5	DKR 90° 1"
25	1"	1 1/4"	20	50	74	126,5	DKR 90° 1 1/4"
31 (32)	1 1/4"	1 1/4"	26	50	80	140	DKR 90° 1 1/4"
31 (32)	1 1/4"	1 1/2"	26	55	80	140	DKR 90° 1 1/2"
38 (40)	1 1/2"	1 1/2"	32	55	93	140	DKR 90° 1 1/2"

ORS

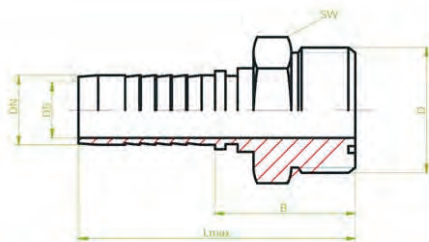

Světlost Hose bore DN	Závit Thread in D	Rozměry mm Dimensions mm				Ozn. přípoje Connection marking	
		D5	SW	B	L		
6	1/4"	9/16"	4	17	25	44	ORS 9/16"
10	3/8"	11/16"	7	22	27	53	ORS 11/16"
12	1/2"	13/16"	10	24	29	61	ORS 13/16"
19 (20)	3/4"	1 3/16"	15	36	37	74	ORS 1 3/16"
25	1"	1 7/16"	21	41	37	83	ORS 1 7/16"

ORFS

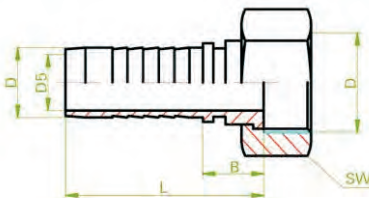

Světlost Hose bore DN	Závit Thread in D	Rozměry mm Dimensions mm				Ozn. přípoje Connection marking	
		D5	SW	B	L		
6	1/4"	9/16"	4	17	23	48	ORFS 9/16"
10	3/8"	11/16"	7	22	23	53	ORFS 11/16"
12	1/2"	13/16"	10	24	24	52	ORFS 13/16"
16	5/8"	1"	13	30	27	65	ORFS 1"
19 (20)	3/4"	1 3/16"	15	36	28	73	ORFS 1 3/16"
25	1"	1 7/16"	21	41	39	83	ORFS 1 7/16"

ORFS 45°

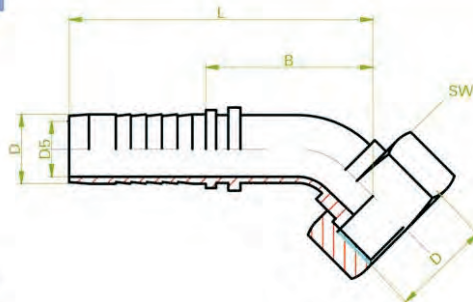
Koleno 45°
Elbow 45°

Světlost Hose bore DN	Závit Thread in D	Rozměry mm Dimensions mm				Ozn. přípoje Connection marking	
		D5	SW	B	L		
6	1/4"	9/16"	4	17	38	57	ORFS 45° 9/16"
10	3/8"	11/16"	7	22	36	62	ORFS 45° 11/16"
12	1/2"	13/16"	10	24	42	74	ORFS 45° 13/16"
16	5/8"	1"	13	30	49	85	ORFS 45° 1"
19 (20)	3/4"	1 3/16"	15	36	52	88	ORFS 45° 1 3/16"
25	1"	1 7/16"	21	41	71	112	ORFS 45° 1 7/16"

BES 45° (RSS 45°)

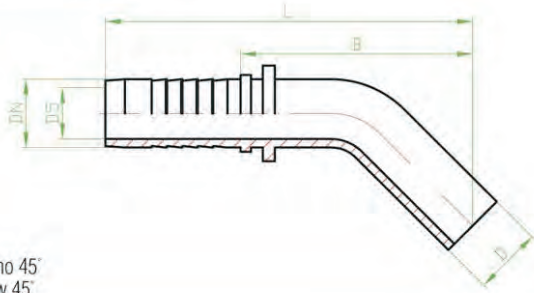

Koleno 45°
Elbow 45°

Světlost Hose bore DN		Trubka Pipe D		Rozměry mm Dimensions mm			Ozn. přípoje Connection marking
in		D5	B	L			
6	1/4"	10	4	53	81	BES 45°	
8	5/16"	12	6	57	84	BES 45°	
10	3/8"	14	7	61	91	BES 45°	
12	1/2"	16	10	77	108	BES 45°	
16	5/8"	20	13	81	115	BES 45°	
19 (20)	3/4"	25	15	91	130	BES 45°	
25	1"	20	21	101	147	BES 45°	
31 (32)	1 1/4"	38	27	110	164	BES 45°	

BES 90° (RSS 90°)

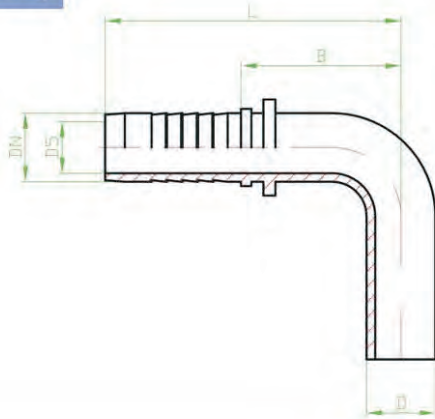

Koleno 90°
Elbow 90°

Světlost Hose bore DN		Trubka Pipe D		Rozměry mm Dimensions mm			Ozn. přípoje Connection marking
in		D5	B	L			
6	1/4"	10	4	40	67	BES 90°	
8	5/16"	12	6	47	74	BES 90°	
10	3/8"	14	7	51	81	BES 90°	
12	1/2"	16	10	62	93	BES 90°	
16	5/8"	20	13	68	102	BES 90°	
19 (20)	3/4"	25	15	74	113	BES 90°	
25	1"	20	21	87	133	BES 90°	
31 (32)	1 1/4"	38	27	100	154	BES 90°	

CEL

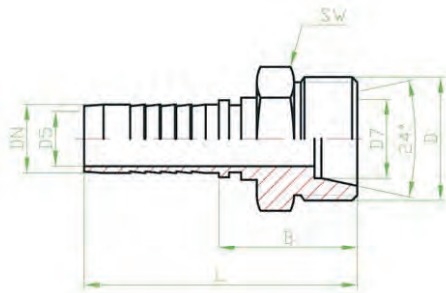

Spojovací čep pro převlečnou matici s kuželovým otvorem 24°, lehká řada
Coupling with a male nipple for cup nut with 24° flare, light series

Světlost Hose bore DN		Závit Thread D		Rozměry mm Dimensions mm				Ozn. přípoje Connection marking
in		SW	D7	D5	B	L		
6	1/4"	M14x1,5	14	8	4	23	50	CEL
8	5/16"	M16x1,5	17	10	6	25	52	CEL
10	3/8"	M18x1,5	19	12	7	24	54	CEL
12	1/2"	M22x1,5	22	15	10	30	61	CEL
16	5/8"	M26x1,5	27	18	13	29	61	CEL
19 (20)	3/4"	M30x2	32	22	15	30	69	CEL
25	1"	M36x2	41	28	20	32	78	CEL
31 (32)	1 1/4"	M45x2	46	35	26	37	91	CEL
38 (40)	1 1/2"	M45x2	46	35	27	55	112	CEL
38 (40)	1 1/2"	M52x2	50	42	33	40	97	CEL

CEL 45°

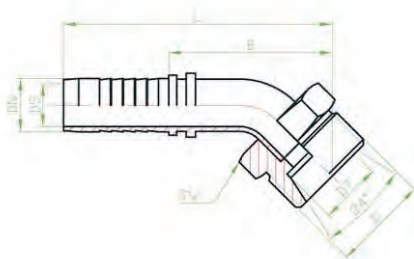

Koleno 45°
Elbow 45°

Světlost Hose bore DN		Závit Thread D		Rozměry mm Dimensions mm				Ozn. přípoje Connection marking
in		SW	D7	D5	B	L		
6	1/4"	M14x1,5	14	8	4	44	71	CEL 45°
8	5/16"	M16x1,5	17	10	6	44	74	CEL 45°
10	3/8"	M18x1,5	19	12	7	43	73	CEL 45°
12	1/2"	M22x1,5	22	15	10	58	89	CEL 45°
16	5/8"	M26x1,5	27	18	13	73	107	CEL 45°
19 (20)	3/4"	M30x2	32	22	15	86	125	CEL 45°
25	1"	M36x2	41	28	20	88	136	CEL 45°
31 (32)	1 1/4"	M45x2	46	35	26	124	177	CEL 45°
38 (40)	1 1/2"	M45x2	46	35	27	123	180	CEL 45°
38 (40)	1 1/2"	M52x2	50	42	33	125	182	CEL 45°

CEL 90°

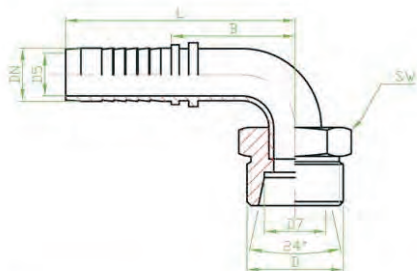

Koleno 90°
Elbow 90°

CES

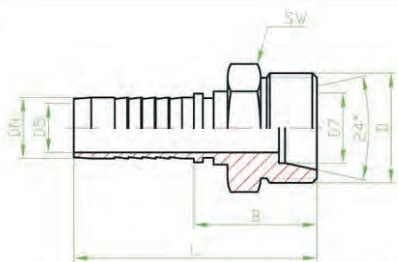

Spojovací čep pro převlečnou matici s kuželovým otvorem 24°, těžká řada
Coupling with a male nipple for cup nut with 24° flare, heavy series

CES 45°

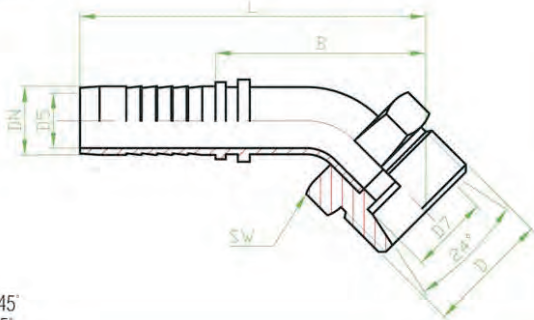

Koleno 45°
Elbow 45°

CES 90°

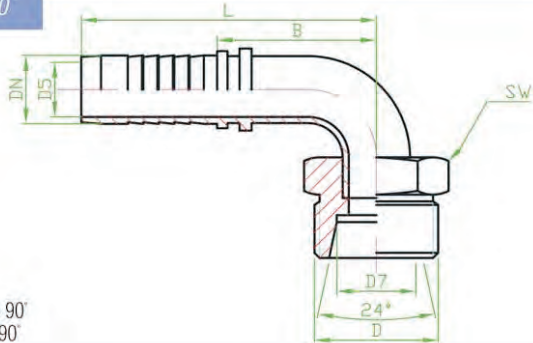

Koleno 90°
Elbow 90°

Světlost Hose bore DN	in	Závít Thread D	Rozměry mm Dimensions mm					Ozn. přípoje Connection marking	
				SW	D7	D5	B	L	
6	1/4"	M14x1,5	14	8	4	26	53	CEL 90°	
8	5/16"	M16x1,5	17	10	6	30	57	CEL 90°	
10	3/8"	M18x1,5	19	12	7	30	60	CEL 90°	
12	1/2"	M22x1,5	22	15	10	42	73	CEL 90°	
16	5/8"	M26x1,5	27	18	13	52	86	CEL 90°	
19 (20)	3/4"	M30x2	32	22	15	60	99	CEL 90°	
25	1"	M36x2	41	28	20	65	111	CEL 90°	
31 (32)	1 1/4"	M45x2	46	35	26	94	148	CEL 90°	
38 (40)	1 1/2"	M45x2	40	35	27	105	162	CEL 90°	
38 (40)	1 1/2"	M52x2	50	42	33	105	162	CEL 90°	

Světlost Hose bore DN	in	Závít Thread D	Rozměry mm Dimensions mm					Ozn. přípoje Connection marking	
				SW	D7	D5	B	L	
6	1/4"	M18x1,5	19	10	4	28	55	CES	
8	5/16"	M20x1,5	22	12	6	28	55	CES	
10	3/8"	M22x1,5	22	14	7	29	59	CES	
12	1/2"	M24x1,5	24	16	10	33	64	CES	
16	5/8"	M30x2	30	20	13	38	72	CES	
19 (20)	3/4"	M36x2	41	25	15	41	80	CES	
25	1"	M42x2	46	30	20	44	90	CES	
31 (32)	1 1/4"	M52x2	55	38	26	50	104	CES	
38 (40)	1 1/2"	M52x2	55	38	32,5	61	118	CES	

Světlost Hose bore DN	in	Závít Thread D	Rozměry mm Dimensions mm					Ozn. přípoje Connection marking	
				SW	D7	D5	B	L	
6	1/4"	M18x1,5	19	10	4	48	75	CES 45°	
8	5/16"	M20x1,5	22	12	6	47	74	CES 45°	
10	3/8"	M22x1,5	22	14	7	47	77	CES 45°	
12	1/2"	M24x1,5	24	16	10	54	86	CES 45°	
16	5/8"	M30x2	30	20	13	67	101	CES 45°	
19 (20)	3/4"	M36x2	41	25	15	81	120	CES 45°	
25	1"	M42x2	46	30	20	89	136	CES 45°	
31 (32)	1 1/4"	M52x2	55	38	26	125	180	CES 45°	
38 (40)	1 1/2"	M52x2	55	38	32,5	123	180	CES 45°	

Světlost Hose bore DN	in	Závít Thread D	Rozměry mm Dimensions mm					Ozn. přípoje Connection marking	
				SW	D7	D5	B	L	
6	1/4"	M18x1,5	19	10	4	26	53	CES 90°	
8	5/16"	M20x1,5	22	12	6	30	57	CES 90°	
10	3/8"	M22x1,5	22	14	7	30	60	CES 90°	
12	1/2"	M24x1,5	24	16	10	42	73	CES 90°	
16	5/8"	M30x2	30	20	13	52	86	CES 90°	
19 (20)	3/4"	M36x2	41	25	15	60	99	CES 90°	
25	1"	M42x2	46	30	20	65	111	CES 90°	
31 (32)	1 1/4"	M52x2	55	38	26	94	148	CES 90°	
38 (40)	1 1/2"	M52x2	55	38	32,5	105	162	CES 90°	

Do objednávky uvádějte světlost hadice a označení přípoje.
Mention hose bore and connection marking in each order.
Rozměry jsou pouze informativní.
Dimensions have only informative character.

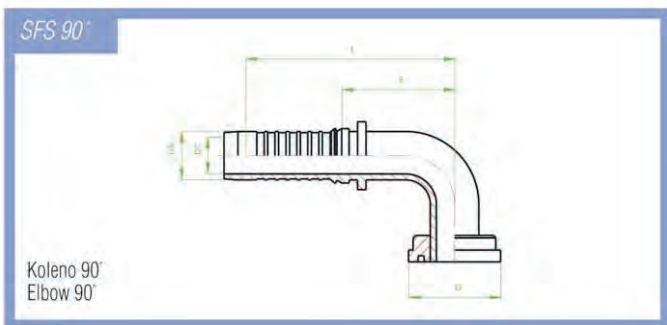

Světlost Hose bore DN	Příruba Flange in	Rozměry mm Dimensions mm	O-kr. O-ring		Ozn. přípoje Connection marking		
			D	D5		B	L
19 (20)	3/4"	41,3	14,8	60	99	24,99x3,53	SFS 90°
25	1"	47,6	20,5	65	111	32,92x3,53	SFS 90°
31 (32)	1 1/4"	54	26,5	94	148	37,69x3,53	SFS 90°
38 (40)	1 1/2"	63,5	30	116	185	47,22x3,53	SFS 90°
51 (50)	2"	79,4	40	130	195	56,75x3,53	SFS 90°

Způsob objednávání vysokotlakých hadic: How to order high-pressure hoses:

DIN 2 SN - DN 10 - 2 200 - DKOL /DKOL 90° M22x1,5 -

Typ hadicoviny/Hose type:

Světlost hadice/Hose inside diameter (DN):

Délka hadice/Length of the hose:

Typ koncovky 1/Coupling type 1:

Typ koncovky 2/Coupling type 2:

Závit koncovky/Coupling thread:

Úhel natočení mezi dvěma úhlovými koncovkami/Angle of turn between two angle couplings:

Náš **další sortiment** zahrnuje:

- hydraulické rychlospojky
- hydraulická šroubení
- hydraulické trubky – ohýbané i metráž
- držáky trubek
- kulové kohouty
- manometry
- armovací zařízení

a je obsažen ve speciálních katalozích.

Our **portfolio** includes:

- hydraulic quick release couplings
- hydraulic screw joints
- hydraulic pipes – bending and length
- brackets for pipes
- ball valves
- manometers
- armouring equipments

all demonstrated in special catalogues.



HOSE SIZE																
				R.O.D.		O.D.		MAX W.P.		BURST PRESSURE		MIN. BEND RADIUS		WEIGHT		FERRULE
DN	dash	mm	inch	mm	inch	mm	inch	bar	psi	bar	psi	mm	inch	g/m	lb/ft	
5	- 3	4,8	3/16"	9,6	0,38	11,6	0,46	250	3620	1150	16670	89	3,50	180	0,12	M03400-03
6	- 4	6,4	1/4"	11,0	0,43	13,0	0,51	225	3260	1000	14500	100	3,94	240	0,16	M03400-04
8	- 5	7,9	5/16"	12,6	0,50	14,6	0,57	215	3110	950	13770	114	4,49	255	0,17	M03400-05
10	- 6	9,5	3/8"	15,0	0,59	17,0	0,67	180	2610	800	11600	127	5,00	360	0,24	M03400-06
12	- 8	12,7	1/2"	18,1	0,71	20,1	0,79	160	2320	680	9860	178	7,01	450	0,30	M03400-08
16	- 10	15,9	5/8"	21,3	0,84	23,3	0,92	130	1880	600	8700	200	7,87	510	0,34	M03400-10
19	- 12	19,0	3/4"	25,2	0,99	27,4	1,08	105	1520	500	7250	240	9,45	650	0,44	M03400-12
25	- 16	25,4	1"	33,1	1,30	35,3	1,39	90	1300	360	5220	300	11,81	960	0,64	M03400-16
31	- 20	31,8	1-1/4"	40,6	1,60	43,3	1,70	65	940	375	5430	419	16,50	1250	0,84	M03400-20
38	- 24	38,1	1-1/2"	47,0	1,85	49,7	1,96	50	720	280	4060	500	19,69	1600	1,07	M03400-24
51	- 32	50,8	2"	60,4	2,38	63,1	2,48	40	580	250	3620	630	24,80	2200	1,47	M03400-32
60	- 38	60,0	2-3/8"	68,8	2,71	71,5	2,81	50	720	200	2900	650	25,59	2210	1,48	M03400-38
63	- 40	63,5	2-1/2"	73,0	2,87	75,7	2,98	50	720	200	2900	760	29,92	2550	1,71	M03400-40
76	- 48	76,2	3"	85,0	3,35	87,7	3,45	35	500	140	2030	900	35,43	2750	1,84	M03400-48

! KEY PERFORMANCE / SPEZIELLE EIGENSCHAFTEN

Superior abrasion resistance ■ High ozone and weather resistance ■ Flame resistance to a wide range of spec. ■ Antistatic and antitoxic cover ■ Large bore sizes (>2") available ■
 Übertagende Abriebbeständigkeit ■ Hohe Ozon und- Wetterbeständigkeit ■ Flammbeständig nach vielen Normen ■ Antistatisch und antitoxische Decke ■ Größere Nennweiten als DN50 verfügbar ■

MAIN APPLICATIONS TYPES: Low-medium pressure lines, return lines, in heavy duty environmental conditions, specific installations with severe abrasion conditions, marine applications, underground and open pit mining

CONTINUOUS SERVICE: -40°F / +212°F

MAX OPERATING TEMPERATURE
(Intermittent service): 257°F

RECOMMENDED FLUIDS: mineral oils, vegetable and rape seed oils, glycol and polyglycol based oils, synthetic ester based oils, oils in aqueous emulsion, water

HAUPT-ANWENDUNGS- GEBIET: Niedriger und mittlerer Druckbereich, Rücklaufleitung, Installationen mit hohem Abrieb, Schiffbau, Bergbau und Tagebau

DAUERBETRIEB: -40°C / +100°C

MAX. BETRIEBSTEMPERATUR: 125°C

EMPFOHLENE MEDIEN: Mineralöl, Pflanzenöl, Rapsöl, Glykol, Öl auf Polyglykolbasis, Synthetik-Esterbasis, Wasser/Ölemulsion, Wasser

INSERT: MF 2000 - MULTIFIT TYPE

TUBE: Oil resistant synthetic rubber

REINFORCEMENT: One high tensile steel braid

COVER: Synthetic rubber with high ozone, weather and heat resistance. MSHA and FRAS approvals

APPLICABLE SPECS.: Exceed EN 853 1SN

SAE 100 R1AT

TYPE APPROVALS: GOST-R, LOBA, MAKNI

NIPPEL: MF 2000 - MULTIFIT

SEELE: Ölbeständiges synthetisches Gummi

DRUCKTRÄGER: Ein hochzugfestes Stahldrahtgeflecht

DECKE: Synthetisches Gummi mit hoher Ozon-, Wetter- und Temperaturbeständigkeit.

Zulassungen: MSHA und FRAS

ANGEWANDTE NORM: Übertrifft EN 853 1SN

SAE 100 R1AT

ZULASSUNGEN: GOST-R, LOBA, MAKNI



HOSE SIZE																
				R.O.D.		O.D.		MAX W.P.		BURST PRESSURE		MIN. BEND RADIUS		WEIGHT		FERRULE
DN	dash	mm	inch	mm	inch	mm	inch	bar	psi	bar	psi	mm	inch	g/m	lb/ft	
5	- 3	4,8	3/16"	11,3	0,44	13,3	0,52	415	6010	2000	29000	89	3,50	295	0,20	M03400-03
6	- 4	6,4	1/4"	12,7	0,50	14,7	0,58	400	5800	1750	25370	100	3,94	360	0,24	M03400-04
8	- 5	7,9	5/16"	14,3	0,56	16,3	0,64	350	5070	1480	21460	114	4,49	395	0,26	M03400-05
10	- 6	9,5	3/8"	16,7	0,66	18,7	0,74	350	5070	1400	20300	127	5,00	505	0,34	M03400-06
12	- 8	12,7	1/2"	19,8	0,78	21,8	0,86	350	5070	1400	20300	178	7,01	640	0,43	M03400-08
16	- 10	15,9	5/8"	23,0	0,91	25,0	0,98	250	3620	1020	14790	200	7,87	710	0,48	M03400-10
19	- 12	19,0	3/4"	27,0	1,06	29,2	1,15	215	3110	900	13050	240	9,45	910	0,61	M03400-12
25	- 16	25,4	1"	34,8	1,37	37,0	1,46	175	2530	670	9710	300	11,81	1293	0,87	M03400-16
31	- 20	31,8	1-1/4"	44,3	1,74	47,0	1,85	140	2030	600	8700	419	16,50	1940	1,30	M03400-20
38	- 24	38,1	1-1/2"	50,7	2,00	53,4	2,10	100	1450	500	7250	500	19,69	2245	1,50	M03400-24
51	- 32	50,8	2"	63,5	2,50	66,2	2,61	90	1300	420	6090	630	24,80	3085	2,07	M03400-32
60	- 38	60,0	2-3/8"	68,8	2,71	71,5	2,81	90	1300	360	5220	650	25,59	2730	1,83	M03400-38
63	- 40	63,5	2-1/2"	75,8	2,98	78,5	3,09	70	1010	300	4350	760	29,92	3670	2,46	M03400-40
76	- 48	76,2	3"	87,8	3,46	90,5	3,56	45	650	180	2610	900	35,43	3270	2,19	M03400-48

KEY PERFORMANCE / SPEZIELLE EIGENSCHAFTEN

Superior abrasion resistance ■ High ozone and weather resistance ■ Flame resistance to a wide range of spec. ■ Antistatic and antitoxic cover ■ Over standard pressure resistance ■ Large bore sizes (>2") available ■
 Übertagende Abriebbeständigkeit ■ Hohe Ozon- und Wetterbeständigkeit ■ Flammbeständig nach vielen Normen ■ Antistatische und antitoxische Decke ■ Größere Nennweiten als DN50 verfügbar ■

MAIN APPLICATIONS TYPES: Medium-high pressure lines in heavy duty environmental conditions, specific installations with severe abrasion conditions, marine applications, underground and open pit mining

CONTINUOUS SERVICE: -40°F / +212°F

MAX OPERATING TEMPERATURE (Intermittent service): 257°F

RECOMMENDED FLUIDS: mineral oils, vegetable and rape seed oils, glycol and polyglycol based oils, synthetic ester based oils, oils in aqueous emulsion, water

HAUPT-ANWENDUNGSGEBIET: Mittlerer Hochdruckbereich mit eingeschränkten Installationsmöglichkeiten bei schwersten Einsatzbedingungen, Installationen mit hohem Abrieb, Schiffbau, Bergbau und Tagebau

DAUERBETRIEB: -40°C / +100°C

MAX. BETRIEBSTEMPERATUR: 125°C

EMPFOHLENE MEDIEN: Mineralöl, Pflanzenöl, Rapsöl, Glykol, Öl auf Polyglykolbasis, Synthetik-Esterbasis, Wasser/Ölemulsion, Wasser

INSERT: MF 2000 - MULTIFIT TYPE

TUBE: Oil resistant synthetic rubber

REINFORCEMENT: Two high tensile steel braids

COVER: Synthetic rubber with high ozone, weather and heat resistance. MSHA and FRAS approvals

APPLICABLE SPECS.: Exceed EN 853 2SN SAE 100 R2AT

TYPE APPROVALS: GOST-R, INDIA MoD, LOBA, MAKNI, WUG

NIPPEL: MF 2000 - MULTIFIT

SEELE: Ölbeständiges synthetisches Gummi

DRUCKTRÄGER: Zwei hochzugfeste Stahldrahtgeflechte

DECKE: Synthetisches Gummi mit hoher Ozon-, Wetter- und Temperaturbeständigkeit. Zulassungen: MSHA und- FRAS

ANGEWANDTE NORM: Übertrifft EN 853 2SN SAE 100 R2AT

ZULASSUNGEN: GOST-R, INDIA MoD, LOBA, MAKNI, WUG