

Part number:

**HYDROMA**

HYDRAULICKÉ SYSTÉMY

**HIDROMA
SYSTEMS**

UKŁADY HYDRAULICZNE

HYDROMA

ГИДРАВЛИЧЕСКИЕ СИСТЕМЫ

Solenoid operated valves pilot operated poppet type

2-way normally closed

Special cavity, 021-E

VEI-16-021-NC

OD.15 - X - 21 - Y - Z

RE 18323-37

Edition: 04.2022

Replaces: 03.2021

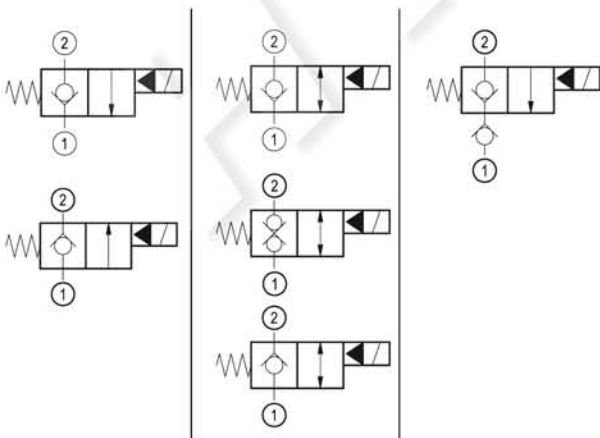
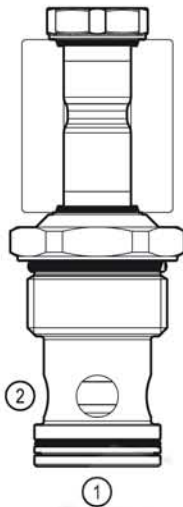
**PATENT PENDING****Technical data**

New VEI-16 family incorporates a new solenoid concept providing excellent performance and enables cartridges to work in severe environment. Cartridges also incorporates advanced design of hydraulic parts providing excellent hydraulic performance.

Technical data

General	
Weight	0.35 kg (0.77 lbs)
Installation orientation	Unrestricted
Storage ambient temperature range	-40 to 100 °C (-40 to 212 °F)
Operating ambient temperature range	-30 to 90 °C (-22 to 194 °F)
Salt spray test to DIN EN ISO 9227:2017-07	500h
Hydraulic	
Max. operating pressure	350 bar (5000 psi)
Flow range	5 - 150 l/min (1 - 40 gpm)
Fatigue cycle life	1 million cycles at 350 bar
Max. internal leakage:	20 drops/min.
Switching time	Closing ≤ 100 ms Opening ≤ 50 ms
Fluid temperature range	-20 to 80 °C (-4 to 176 °F)
Fluids: Mineral-based or synthetics with lubricating properties at viscosities of 20 to 380 mm ² /s (cSt)	
Installation torque	130 - 150 Nm (96 - 111 ft-lbs)
Recommended degree of fluid contamination	Nominal value max. 10 µm (NAS 8) ISO 4406 19/17/14
MTTFD	150 years see RE 18350-51
Special cavity	021-E see 18325-75
Seal kit for X=01,05	code RG21E201052010 material no. R934003566
Seal kit for X=03,09,11,31	code RG21E201053010 material no. R934003567
Seal kit coil and standard cap	code RG02Z0010000100 material no. R930067869
Seal kit coil and protective cap only for Y=D	code RG03Z0010000100 material no. R930067870
Other technical data	See data sheet 18350-50
Electrical	
Type of voltage	DC voltage
Coil type	D36
Supply voltage	See data sheet 18325-90
Voltage tolerance against ambient temperature	See characteristic curve
Power consumption	20 W
Type of protection	See data sheet 18325-90
Note: Coils must be ordered separately	

Ordering code

OD.15	X	21	Y	Z	0000	*
--------------	----------	-----------	----------	----------	-------------	----------

Solenoid operated valves
pilot operated poppet type
2-way normally closed

Series O/A to L
unchanged performances and dimensions

monodirectional type

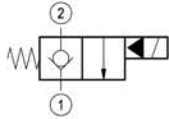

01

bidirectional type

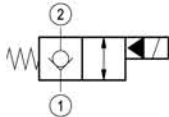

05

monodirectional type with check

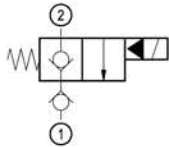

11

bidirectional type

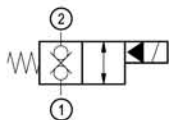

31

bidirectional type

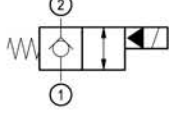

03

monodirectional type

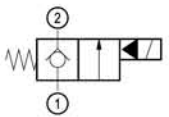

09

0 = With buna seal
8 = With buna seal and extra spring
V = With Viton seal
P = With buna seal and protective cap for override version **D**
T = With Viton seal and protective cap for override version **D**

A = Standard
D = Knob style manual override
E = Pull style manual override
F = Hand operated pull style manual override

Special cavity: 021-E

Preferred types

Type	Material number
OD150121A000000	R930064100
OD150521A000000	R930064472
OD150521A800000	R930065846
OD150521D000000	R930066968
OD151121A000000	R930068693
OD151121D000000	R930065027
OD153121A000000	R930068523
OD153121A800000	R930069360
OD153121D000000	R930068526

Type	Material number
OD153121D800000	R930069505
OD150521D800000	R930070647
OD150321A000000	R930070069
OD150321D000000	R930069699
OD150321D800000	R930070199
OD150921A000000	R930068524
OD150121A800000	R930068927

Characteristic curves

All Versions - Admissible supply voltage Vs. Ambient temperature at 100% duty cycle

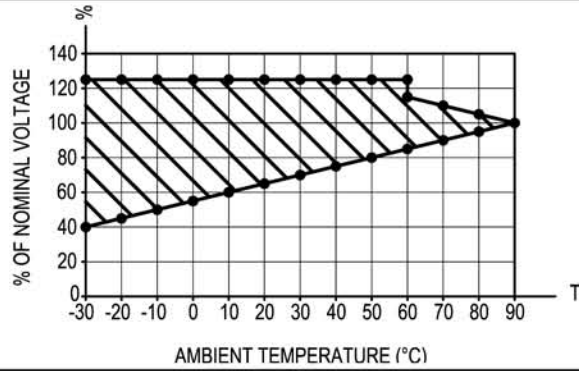

Versions 01, 05

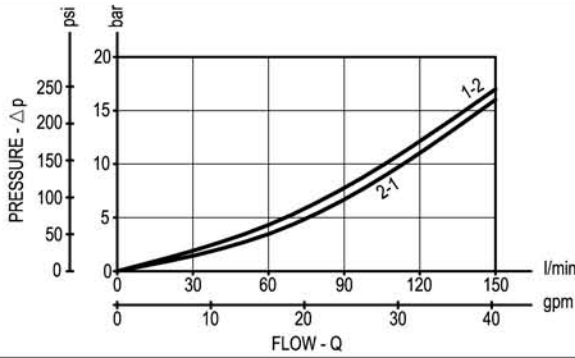

Version 11

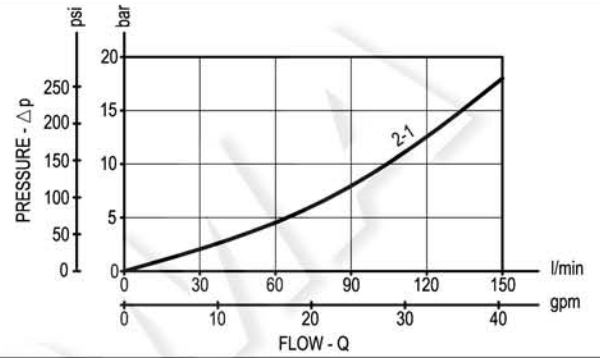

Version 31

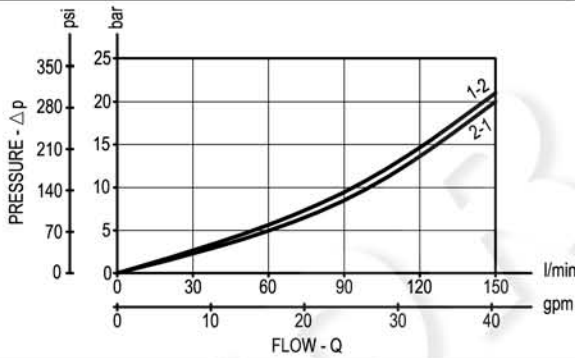

Version 03

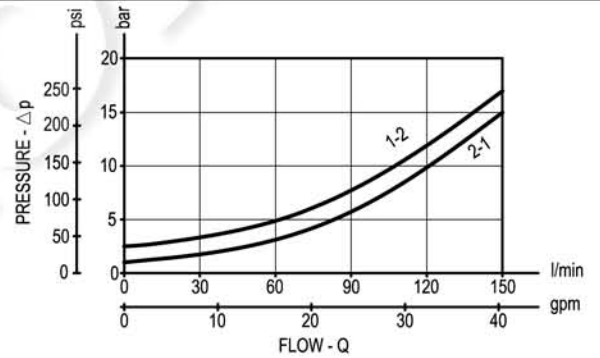

Version 09

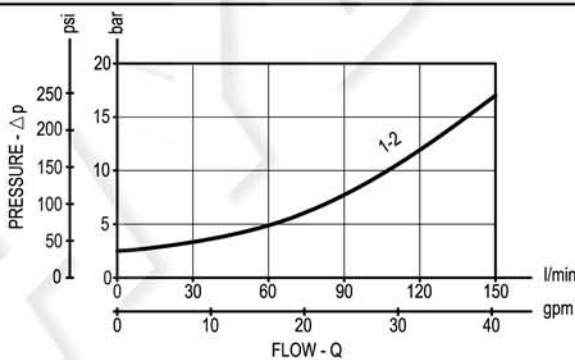

Dimensions

Solenoid operated valves, poppet 2-way normally closed

