

Part number:

**HYDROMA**

HYDRAULICKÉ SYSTÉMY

**HIDROMA  
SYSTEMS**

UKŁADY HYDRAULICZNE

**HYDROMA**

ГИДРАВЛИЧЕСКИЕ СИСТЕМЫ

## 6/2 ways/positions flow diverters L753.... (VS311-VS312-VS315)

**RE 18302-07**

Edition: 04.2016

Replaces: 02.2016



Size 10

Series 00

Maximum operating pressure 310 bar (4500 psi)

Maximum flow 140 l/min (36.98 gpm)

Ports G 1/2 - G 3/4 - SAE12

### General specifications

6 way 2 position valve.

Directional spool valve with direct solenoid control.

Hydraulic / pneumatic pilot , or manual push and twist control available as option.

Control spool operated by solenoid, with easily removable coil fastened by a ring nut.

Wet pin tube for DC coil, with push rod for mechanical override in case of voltage shortage.

Unrestricted 360° orientation of DC coil.

Control spool held in normal position by return spring.

Optional manual override (push-button or screw type).

Connectors available: DIN 43650 – ISO 4400, AMP

Junior, DT04-2P (Deutsch), Free leads.

### Contents

Ordering details	2
Symbols	2
Functional description	3
Technical data	3
Characteristic curves	5
External dimensions and fittings	6
Electric connection	8

## Ordering details

01	02	03	04	05	06	07	08
L	7	53					0

### Family

01	Compact directional valve	L
----	---------------------------	---

### Type

02	Flow diverters	7
----	----------------	---

### Ports

03	G 1/2 DIN 3852	4
	G 3/4 DIN 3852	5
	1 1/16-12 UN (SAE12)	E

### Control type

04	Solenoid (coil C 65) without manual override	14
	Solenoid (coil C 65) with push-button type manual override	4P
	Solenoid (coil C65) with screw type manual override zinc plated screw	4F
	Solenoid (coil C65) with screw type manual override with stainless steel screw	4X
	Hydraulic / pneumatic control <sup>1)</sup>	P1
	Manual push and twist control	H1

### Spool variants

05	6 way / 2 position P1 side	6_
----	----------------------------	----

### Drain type

	6A	6B	6E	6F	6G	
06	Internal drain	●	●	-	●	I
	External drain	●	●	●	-	E

### Voltage supply

	31	07	03	01	00	
07	Without coil	-	-	-	-	00
	12 V DC	●	●	●	●	OB
	13 V DC	-	●	-	●	AD
	24 V DC	●	●	●	●	OC
	27 V DC	-	●	-	●	AC
	48 V DC	-	-	-	●	OD

### Electric connections

08	Without coils	00
	With coils, without mating connector DIN EN 175301-803 <sup>2)</sup>	01
	With coils, with bi-directional diode, without mating connector vertical Amp-Junior	03
	With coils, with bi-directional diode, without mating connector DT04-2P	07
	With coils and bipolar sheathed lead 350mm (13,8 in) long	31

● = Available    - = Not available

## Symbols

### Drain type I

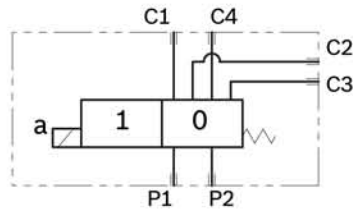

### Drain type E

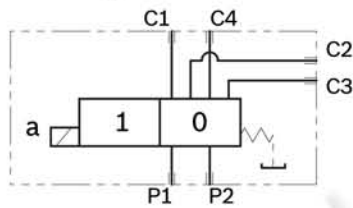

### Spool variants

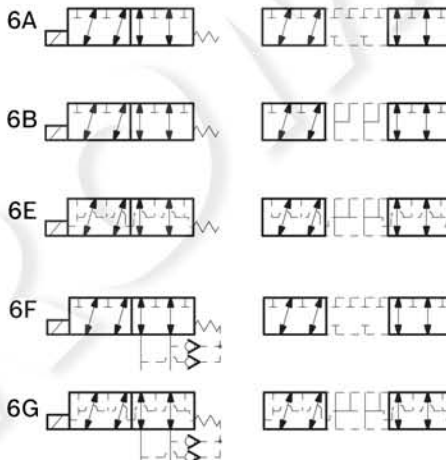

- 1) Minimum pressure 4 bar (58psi) with external drain (E), maximum pressure 200 bar (2901psi). With internal drain (I), at the minimum pressure (4 bar - 58psi), add the working pressure with ratio of 11:1. Example: With working pressure 100 bar (1450psi), minimum pilot pressure is 13.09 bar (190psi)  $((100:11) + 4 \text{ bar (58psi)})$ .
- 2) For connectors ordering code see data sheet RE 18325-90.

## Functional description

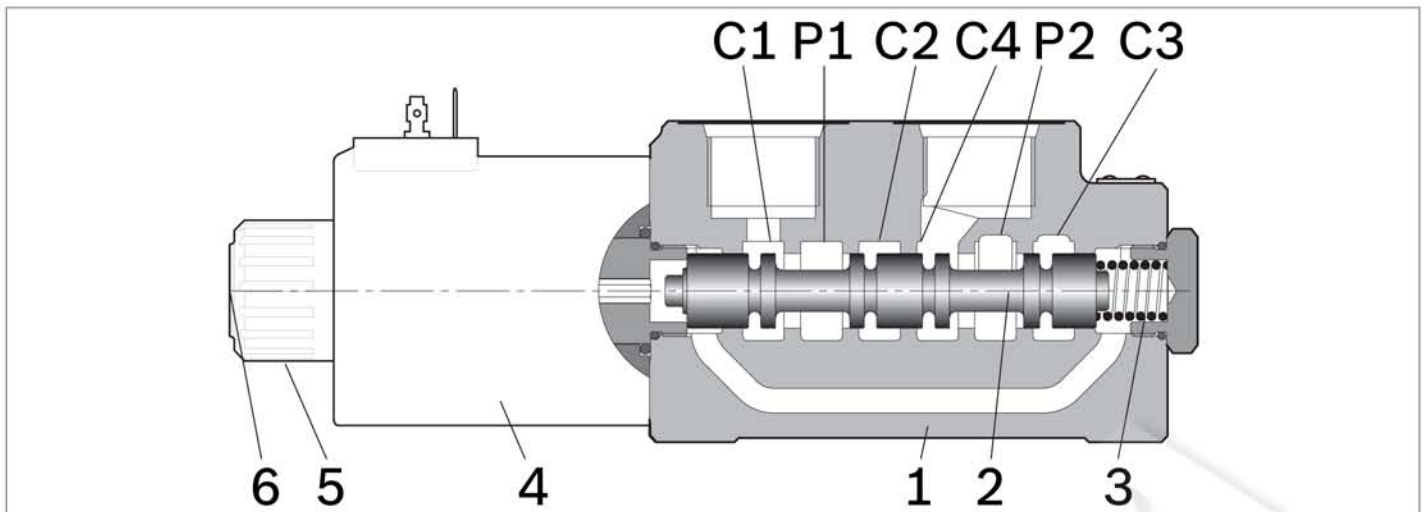

A valve basically consists of a housing (1), a control spool (2), a return spring (3) and a solenoid (5). It is designed to connect two inlet lines P1 – P2 (normally a set of hoses) and divert them to either the outlet ports (C1 – C4) with spool in position “0”, when the solenoid is de-energized, or to the outlet ports (C2 – C3) with spool in position “1”, when the solenoid is energized.

With the coil de-energized, the return spring (3) pushes

back the spool (2) and holds it in position “0”.

The coil (5) is fastened to the tube by the ring nut (6).

The manual override (6) allows to shift the spool (2) also in case of voltage shortage.

An external drain, to be connected to tank, ensures shifting operations also at higher working pressure.

Hydraulic / pneumatic pilot control for spool shifting is available upon request.

## Technical data

General		
Valve weight	kg (lbs)	5.1 (11.2)
Mounting position		unrestricted
Ambient Temperature	°C (°F)	-20...+50 (-4...+122) (NBR seals)
Hydraulic		
Maximum pressure with external drain (“E” type)	bar (psi)	310 (4500)
Maximum pressure with internal drain (“I” type)	bar (psi)	250 (3625)
Maximum pressure with internal drain and 6F or 6G scheme	bar (psi)	310 (4500)
Maximum flow	l/min (gpm)	140 (36.98)
Pilot pressure needed for hydraulic / pneumatic control	bar (psi)	max 200 (2900) - min 4 (58) with external drain. For versions with internal drain, the pilot pressure required should be at least 11 times higher than inlet pressure (ratio 11:1).
Hydraulic fluid General properties: it must have physical lubricating and chemical properties suitable for use in hydraulic systems such as, for example:		Mineral oil based hydraulic fluids HL (DIN 51524 part 1). Mineral oil based hydraulic fluids HLP (DIN 51524 part 2). For use of environmentally acceptable fluids (vegetable or polyglycol base) please consult us.
Fluid Temperature	°C (°F)	-20...+80 (-4...+176) (NBR seals)
Permissible degree of fluid contamination		ISO 4572: $\beta_x \geq 75$ X = 12...15 ISO 4406: class 20/18/15 NAS 1638: class 9
Viscosity range	mm <sup>2</sup> /s	5...420
Internal leakage with 100 bar (1450 psi) secondary pressure at C	cc/min (in <sup>3</sup> /min)	min. 15 (0.9) - max. 40 (2.4)

4 **L753.... (VS311-VS312-VS315)** | 6/2 ways/positions flow diverters  
 Technical data

Electrical						
Voltage type		DC				
Voltage tolerance (nominal voltage)	%	-10 .... +10				
Duty		Continuous, with ambient temperature ≤ 50°C (122°F)				
Coil wire temperature not to be exceeded	°C (°F)	150 (302)				
Insulation class		H				
Compliance with		Low Voltage Directive LVD 73/23/EC (2006/95/EC), 2004/108/EC				
Coil weight with DIN 43650 – ISO 4400 connector	kg (lbs)	1.05 (2.3)				
Voltage	V	12	13	24	27	48
Voltage type		DC	DC	DC	DC	DC
Power consumption	W	44	44	44	44	44
Current (nominal at 20 °C (68 °F))	A	3.6	3.4	1.8	1.6	0.9
Resistance (nominal at 20 °C (68 °F))	Ω	3.2	3.6	12.8	16.9	50.5

**Note**

For applications with different specifications consult us

Code	Voltage [V]	Connector type	Coil description	Marking	Coil Mat no.
<b>OB 01</b>	12 DC	EN 175301-803 (Ex. DIN 43650)	C6501 12DC	12 DC	R933000100
<b>OB 03</b>	12 DC	AMP JUNIOR	C6503 12DC	12 DC	R933000119
<b>OB 07</b>	12 DC	DEUTSCH DT 04-2P	C6507 12DC	12 DC	R933000107
<b>OB 31</b>	12 DC	Cable 350 mm long	C6531 12DC	12 DC	R933000104
<b>AD 01</b>	13 DC	EN 175301-803 (Ex. DIN 43650)	C6501 13DC	13 DC	R933000101
<b>AD 07</b>	13 DC	DEUTSCH DT 04-2P	C6507 13DC	13 DC	R933000112
<b>OC 01</b>	24 DC	EN 175301-803 (Ex. DIN 43650)	C6501 24DC	24 DC	R933000102
<b>OC 03</b>	24 DC	AMP JUNIOR	C6503 24DC	24 DC	R933000120
<b>OC 07</b>	24 DC	DEUTSCH DT 04-2P	C6507 24DC	24 DC	R933000111
<b>OC 31</b>	24 DC	Cable 350 mm long	C6531 24DC	24 DC	R933000110
<b>AC 01</b>	27 DC	EN 175301-803 (Ex. DIN 43650)	C6501 27DC	27 DC	R933000103
<b>AC 03</b>	27 DC	AMP JUNIOR	C6503 27DC	27 DC	R93307055
<b>AC 07</b>	27 DC	DEUTSCH DT 04-2P	C6507 27DC	27 DC	R933000113
<b>OD 01</b>	48 DC	EN 175301-803 (Ex. DIN 43650)	C6501 48DC	48 DC	R933000114

### Characteristic curves

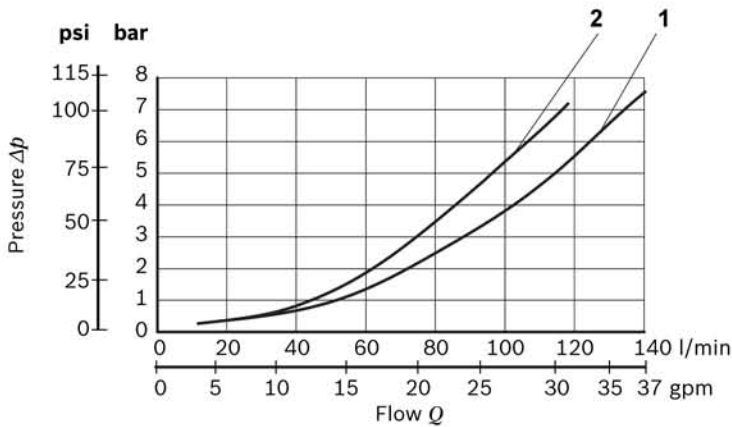

Model	Curve no.			
	P1>C1	P1>C2	P2>C4	P2>C3
VS311	2	2	2	2
VS312-VS315	1	1	1	1

Measured with hydraulic fluid ISO-VG32 at 45° ±5 °C (113° ±9 °F); ambient temperature 20 °C (68 °F).

### DI-DE performance limits

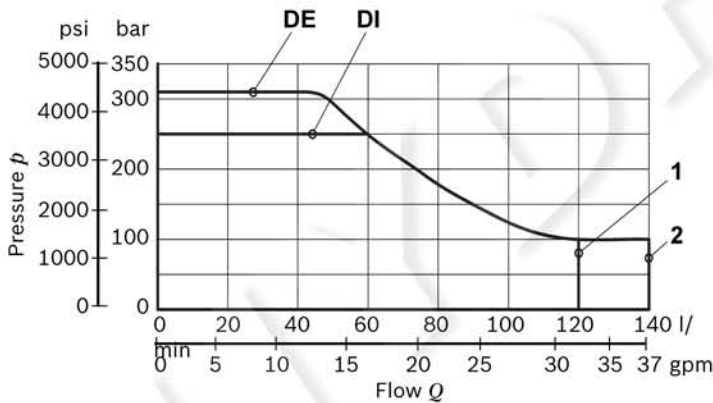
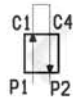

Model	Curve no.
VS311	1
VS312-VS315	2

Flow across both ways: forward across P1>C1 and reverse across C4>P2

**External dimensions and fittings**

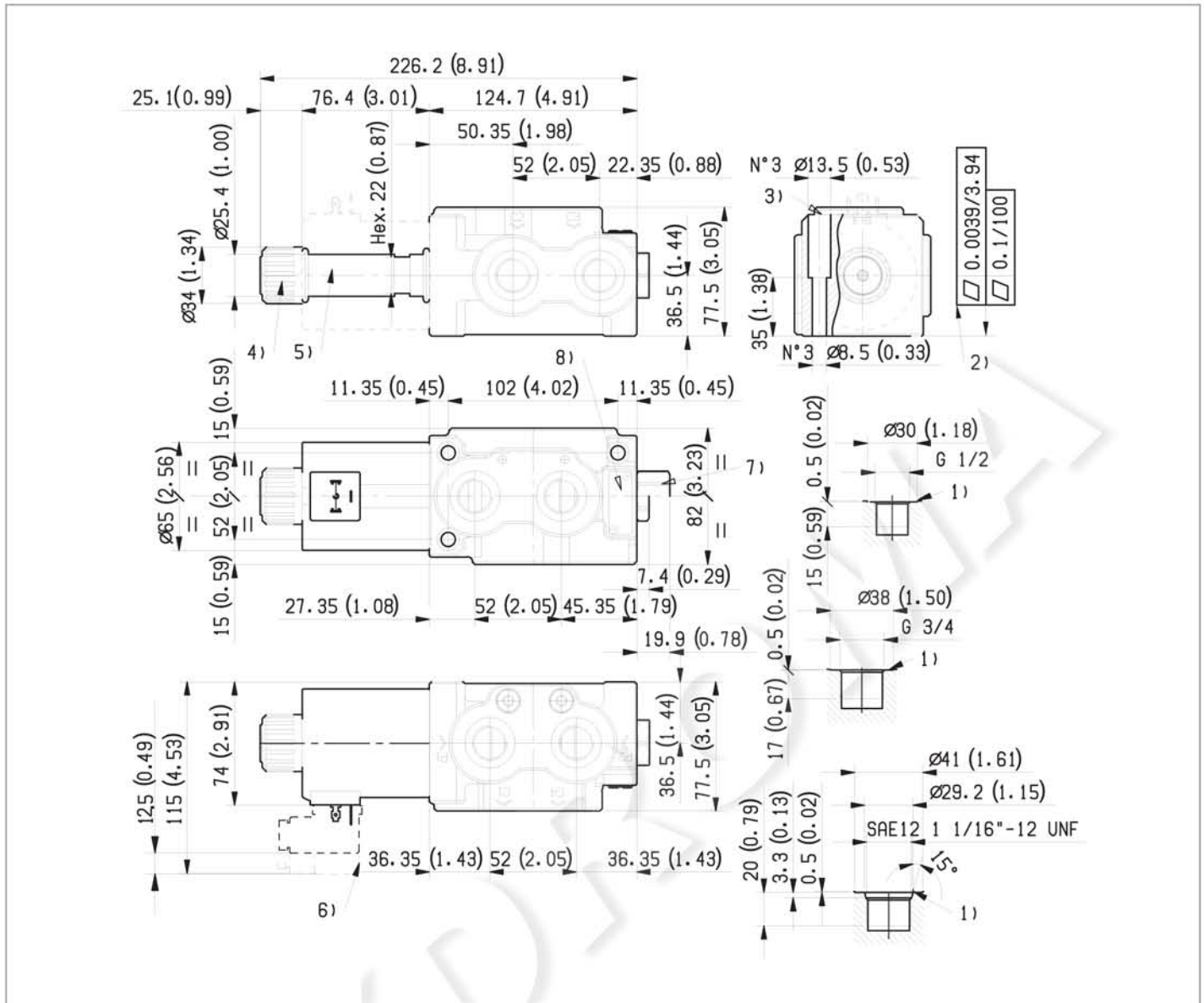

- 1 Ports P1, P2, C1, C2, C3, C4.
- 2 The mounting surface flatness must comply with specifications.
- 3 Two through holes recommended screws M8x45 with strength class DIN 8.8.  
Torque 15 – 16 Nm (11.1–11.8 ft-lb).
- 4 Ring nut for coil locking  $\varnothing$  34 mm (1.34 inch).  
Torque 7–8 Nm (5.2 – 5.9 ft-lb).
- 5 Solenoid tube  $\varnothing$  25,4 mm (1.00 inch).
- 6 Minimum clearance needed for connector removal.

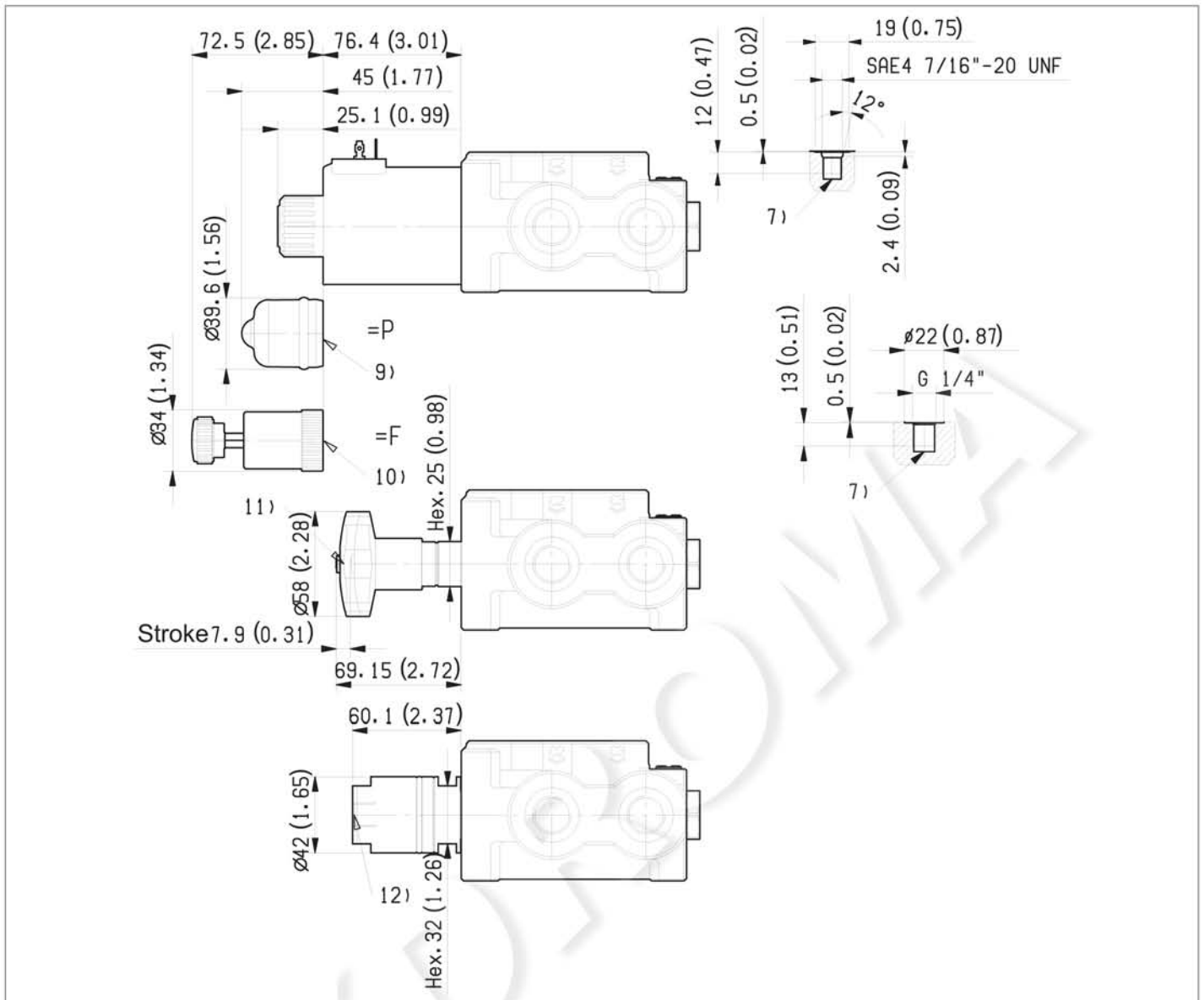

7 External drain plug available with G 1/4 and SAE 4 port.

8 Identification label.

9 Optional push-button, 4P type, manual override for spool opening: it is pressure stuck to the ring nut for coil locking.  
Mat no. R933003424

10 Optional screw type manual override, 4F or 4X types, for spool opening: it is screwed (torque 8-9 Nm (5.9-6.6 ft-lb)) to the tube as replacement of the coil ring nut. Mat no. R933003713 zinc plated, Mat no. R933009577 stainless steel.

11 Dimensions of manual version, push and twist type.

12 Dimensions of hydraulic / pneumatic piloted version. Pilot port plug available with G 1/4.

**Electric connection**

