

Part number:

006-10029

HYDROMA

HYDRAULICKÉ SYSTÉMY

**HIDROMA
SYSTEMS**

UKŁADY HYDRAULICZNE

HYDROMA

ГИДРАВЛИЧЕСКИЕ СИСТЕМЫ

**DIVISORI - RIUNIFICATORI DI FLUSSO
FLOW DIVIDERS - COMBINERS**

A-DRF16

OM.E1.21.90 - Y - Z

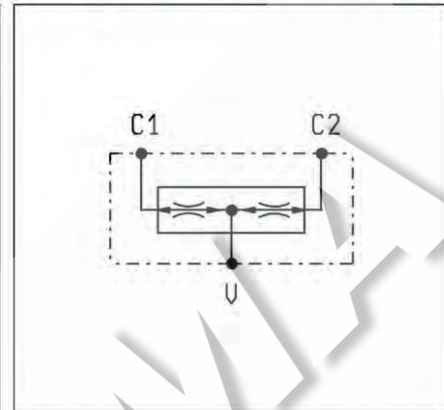
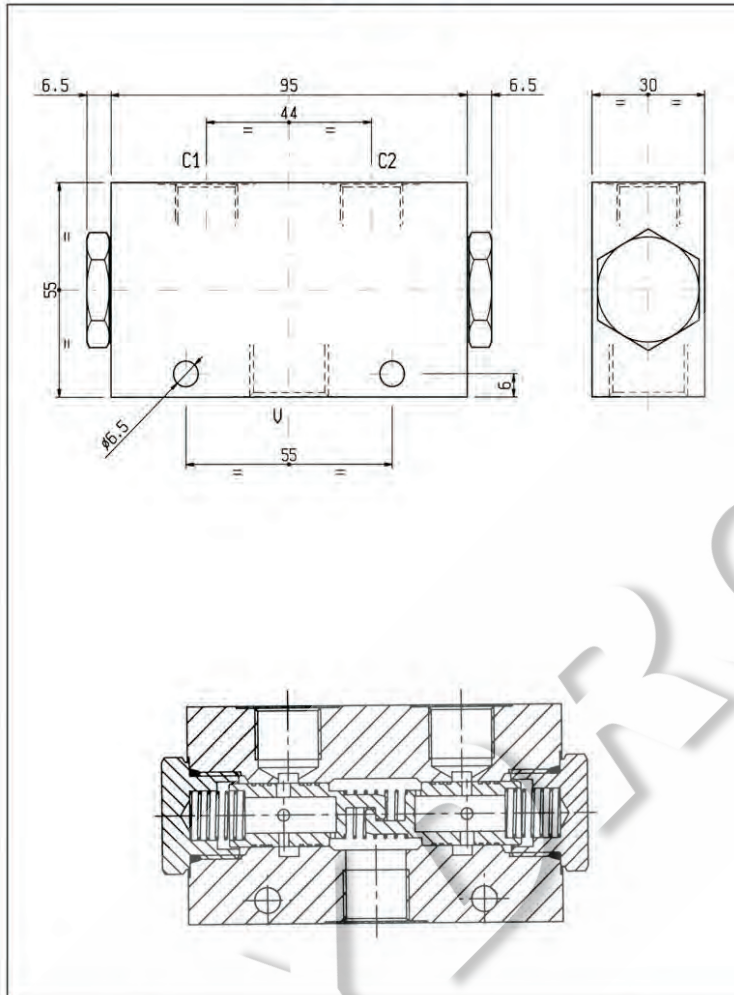

DATI TECNICI / TECHNICAL DATA

Pressione di lavoro max. 315 bar
Max. working pressure

Peso 1.1 kg
Weight

Rapporto di divisione 50%-50%
a richiesta sono disponibili rapporti diversi:
40%-60%
Flow division ratios: 50%-50% standard
40%-60% on request

Classe di pulizia dell'olio: almeno 18/14 ISO 4406
(9 NAS-1638).
Fluid cleanliness class: 18/14 ISO 4406
(9 NAS-1638) or better.

Collettore in acciaio
Steel body

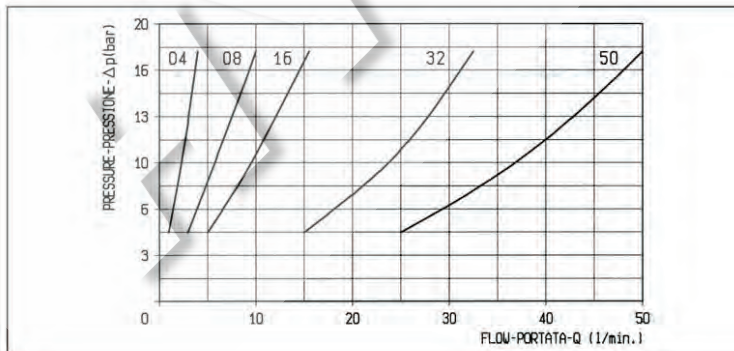

Y	ATTACCHI / PORT SIZE	
	V	C1-C2
02	G 3/8	G 3/8
03	G 1/2	G 3/8

Z	CAMPO DI PORTATA CONSIGLIATO (MAX ERRORE ± 2%) INLET CAPACITY (MAX ADMITTED SLIPPAGE ± 2%)
04	da 2 a 4 l/min 2 to 4 l/min
08	da 4 a 8 l/min 4 to 8 l/min
16	da 8 a 16 l/min 8 to 16 l/min
32	da 16 a 32 l/min 16 to 32 l/min
50	da 25 a 50 l/min 25 to 50 l/min