

Part number:

006-10046

HYDROMA

HYDRAULICKÉ SYSTÉMY

**HIDROMA
SYSTEMS**

UKŁADY HYDRAULICZNE

HYDROMA

ГИДРАВЛИЧЕСКИЕ СИСТЕМЫ

**MASSIMA PRESSIONE, DIRETTE, OTTURATORE CONICO
DIRECT, POPPET TYPE RELIEF**

VS-30

04.11.18 - X - Y - Z

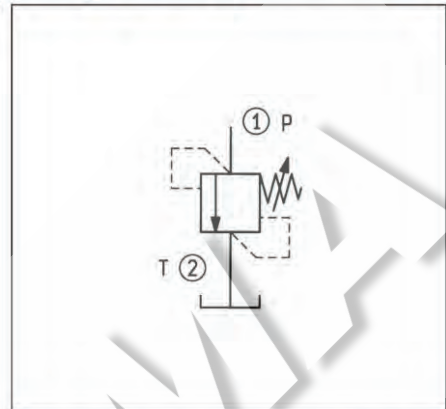
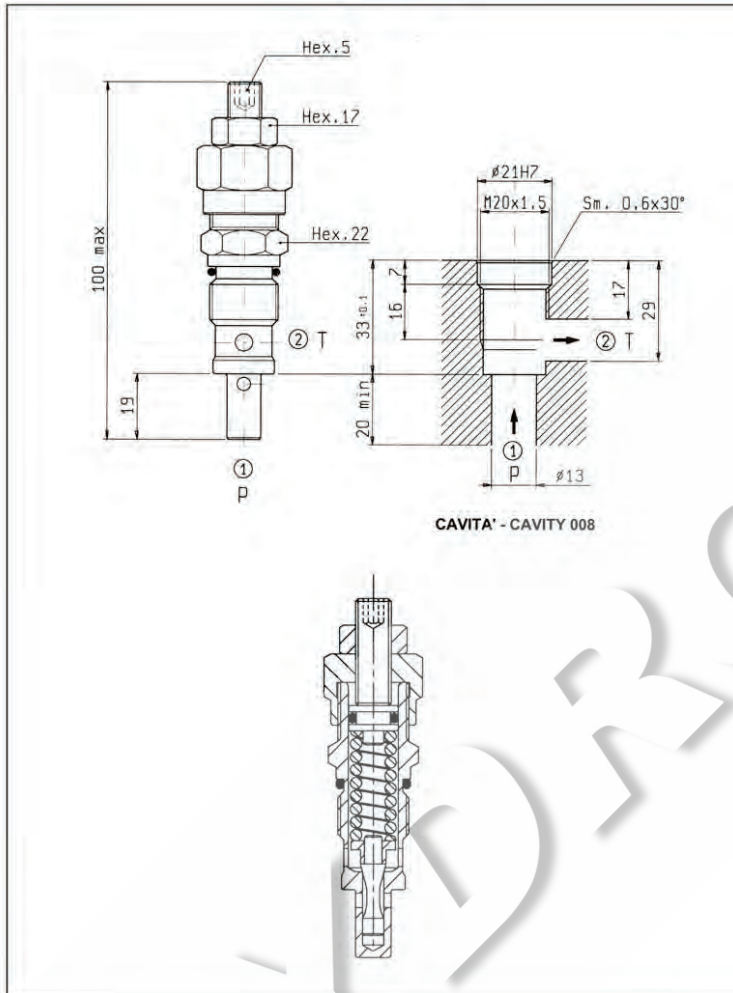

DATI TECNICI / TECHNICAL DATA

Coppia di serraggio Installation torque	46-51 Nm
Pressione di lavoro max. Max. working pressure	350 bar
Portata max. Flow max.	30 l/min
Peso Weight	0.17 kg

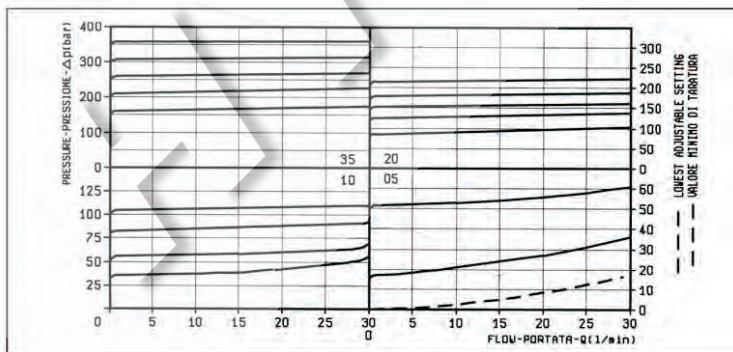

X	REGOLAZIONI ADJUSTMENTS	
03	vite esterna esagono incassato leakproof hex. socket screw	
04	volantino e dado handknob and locknut	
	cappello per piombatura sealing cap codice / ordering code 03.05.01.003	

MOLLE / SPRINGS					
Z	Campo taratura min - max bar Adj. press. range bar	Incremento press. bar / giro vite Press. increase bar / turn	Taratura standard bar (Q = 5 l/min) Std. setting bar (Q = 5 l/min)	Cod. ordinazione Ordering code	Colore Colour
05	5-50	12	50	03.51.01.077	nero black
10	30-100	24	100	03.51.01.076	blu blue
20	50-210	47	200	03.51.01.075	verde green
35	100-350	82	350	03.51.01.059	giallo yellow

Y		ATTACCHI / PORT SIZE
99		Cartuccia/Cartridge