

Part number:

HYDROMA

HYDRAULICKÉ SYSTÉMY

**HIDROMA
SYSTEMS**

UKŁADY HYDRAULICZNE

HYDROMA

ГИДРАВЛИЧЕСКИЕ СИСТЕМЫ

FRA

RETURN FILTERS

DESCRIPTION

Tank top return line filter

MATERIALS

Head and cover: Aluminum alloy

Bowl: Polyamide for FRA21-31-32-33-41

Zinc plated steel for FRA11-42-51-52- 53-5D

Bypass valve: Polyamide

Seals: NBR Nitrile - FKM Fluoroelastomer on request

Indicator housing: Brass

PRESSURE

Max. working: 300 kPa (3 bar)

Collapse, differential for the filter element (ISO 2941): 300 kPa (3 bar)

BYPASS VALVE

Setting: 170 kPa (1,7 bar) \pm 10%

FLOW RATE

Qmax 700 l/min

WORKING TEMPERATURE

From -25° to +110° C

COMPATIBILITY (ISO 2943)

Full with fluids: HH-HL-HM-HV-HTG

(according to ISO 6743/4)

For fluids different than the above mentioned,
please contact our Customer Service.

HYDRAULIC DIAGRAM

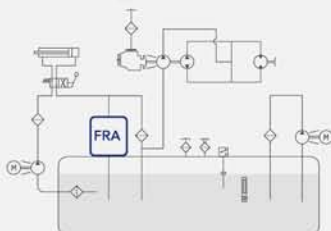

Is this datasheet the latest release? Please check on our website

FRA



RETURN FILTERS

ORDERING AND OPTION CHART

F	R	A	COMPLETE FILTER FAMILY														FILTER ELEMENT FAMILY	E	R	A		
			SIZE & LENGTH	11	21	31	32	33	41	42	51	5A	52	5B	5C	53	5D	SIZE & LENGTH				
			PORT TYPE																			
			B = BSP thread	B	B	B	B	B	B	B	B	B	B	B	B	B	B	B				
			N = NPT thread	N	N	N	N	N	N	N	N	N	N	N	N	N	N	N				
			S = SAE thread	-	S	S	S	S	S	S	S	S	S	S	S	S	S	S				
			F = SAE flange 3000 psi	-	-	-	-	-	-	-	F	F	F	F	F	F	F	F				
			PORT SIZE																			
			03 = 3/8"	03	-	-	-	-	-	-	-	-	-	-	-	-	-	-				
			04 = 1/2"	-	04	04	-	-	-	-	-	-	-	-	-	-	-	-				
			06 = 3/4"	-	-	06	06	06	-	-	-	-	-	-	-	-	-	-				
			08 = 1"	-	-	-	08	08	08	08	-	-	-	-	-	-	-	-				
			10 = 1" 1/4 (F10 not available)	-	-	-	-	-	10	10	10	10	10	-	-	-	-	-				
			12 = 1" 1/2 (* F12 available only for FRA4+ only)	-	-	-	-	-	(*)	(*)	12	12	12	-	-	-	-	-				
			16 = 2" (F16 not available)	-	-	-	-	-	-	-	16	16	16	16	16	16	16	16				
			20 = 2" 1/2 (F20 only)	-	-	-	-	-	-	-	20	20	20	20	20	20	20	20				
			BYPASS VALVE																			
			B = 170 kPa (1,7 bar)	X	B	B	B	B	B	B	B	B	B	B	B	B	B	B				
			SEALS																			
			N = NBR Nitrile	N	N	N	N	N	N	N	N	N	N	N	N	N	N	N				
			F = FKM Fluoroelastomer	F	F	F	F	F	F	F	F	F	F	F	F	F	F	F				
			G = Treatment for water-glycol	G	G	G	G	G	G	G	G	G	G	G	G	G	G	G				
			FormulaUFI MEDIA																			
			FA = FormulaUFI.MICRON 5 μm , $\beta > 1.000$	FA	FA	FA	FA	FA	FA	FA	FA	FA	FA	FA	FA	FA	FA	FA				
			FB = FormulaUFI.MICRON 7 μm , $\beta > 1.000$	FB	FB	FB	FB	FB	FB	FB	FB	FB	FB	FB	FB	FB	FB	FB				
			FC = FormulaUFI.MICRON 12 μm , $\beta > 1.000$	FC	FC	FC	FC	FC	FC	FC	FC	FC	FC	FC	FC	FC	FC	FC				
			FD = FormulaUFI.MICRON 21 μm , $\beta > 1.000$	FD	FD	FD	FD	FD	FD	FD	FD	FD	FD	FD	FD	FD	FD	FD				
			CC = FormulaUFI.CELL 10 μm $\beta > 2$	CC	CC	CC	CC	CC	CC	CC	CC	CC	CC	CC	CC	CC	CC	CC				
			CD = FormulaUFI.CELL 25 μm $\beta > 2$	CD	CD	CD	CD	CD	CD	CD	CD	CD	CD	CD	CD	CD	CD	CD				
			ME = FormulaUFI.WEB 60 μm	ME	ME	ME	ME	ME	ME	ME	ME	ME	ME	ME	ME	ME	ME	ME				
			CLOGGING INDICATOR																			
			01 = 1/8" port, plugged	01	01	01	01	01	01	01	01	01	01	01	01	01	01	01				
			30 = pressure gauge, rear connection	30	30	30	30	30	30	30	30	30	30	30	30	30	30	30				
			32 = pressure gauge, bottom connection	32	32	32	32	32	32	32	32	32	32	32	32	32	32	32				
			P1 = SPDT pressure switch	P1	P1	P1	P1	P1	P1	P1	P1	P1	P1	P1	P1	P1	P1	P1				
			ACCESSORIES																			
			W = without	W	W	W	W	W	W	W	W	W	W	W	W	W	W	W				
			P = with filling plug	P	P	P	P	P	P	P	P	P	P	P	P	P	P	P				
		X	ACCESSORIES																			
			X = no other accessory available	X	X	X	X	X	X	X	X	X	X	X	X	X	X	X				



SPARE PARTS

FILTER HOUSING	FILTER ELEMENT	CLOGGING INDICATOR	ACCESSORIES																										
																													
<table border="1" style="border-collapse: collapse; width: 100px;"> <tr> <td style="width: 15px;">B</td><td style="width: 15px;">R</td><td style="width: 15px;">A</td><td style="width: 15px;"></td><td style="width: 15px;"></td><td style="width: 15px;"></td><td style="width: 15px;">B</td><td style="width: 15px; background-color: black;"></td><td style="width: 15px;"></td><td style="width: 15px;"></td><td style="width: 15px;">X</td> </tr> </table>	B	R	A				B				X	<table border="1" style="border-collapse: collapse; width: 100px;"> <tr> <td style="width: 15px;">E</td><td style="width: 15px;">R</td><td style="width: 15px;">A</td><td style="width: 15px;"></td><td style="width: 15px;"></td><td style="width: 15px;"></td><td style="width: 15px;"></td><td style="width: 15px;"></td><td style="width: 15px;"></td><td style="width: 15px;"></td><td style="width: 15px;"></td> </tr> </table>	E	R	A									<table border="1" style="border-collapse: collapse; width: 40px;"> <tr> <td style="width: 20px;"></td><td style="width: 20px;"></td> </tr> </table>			<table border="1" style="border-collapse: collapse; width: 40px;"> <tr> <td style="width: 20px;"></td><td style="width: 20px;">X</td> </tr> </table>		X
B	R	A				B				X																			
E	R	A																											
	X																												

SPARE SEAL KIT

	NBR	FKM
FRA11	521.0032.2	521.0039.2
FRA21	521.0012.2	521.0040.2
FRA31-32-33	521.0013.2	521.0041.2
FRA41-42	521.0014.2	521.0043.2
FRA51-5A-52-5B-5C-53-5C	521.0015.2	521.0044.2

SPARE SPRING

FRA11	008.0032.1
FRA21	008.0149.1
FRA31-32-33	008.0003.1
FRA41-42	008.0151.1
FRA51-5A-52-5B-5C-53-5C	008.0028.1

FRA

RETURN FILTERS

INSTALLATION DRAWING

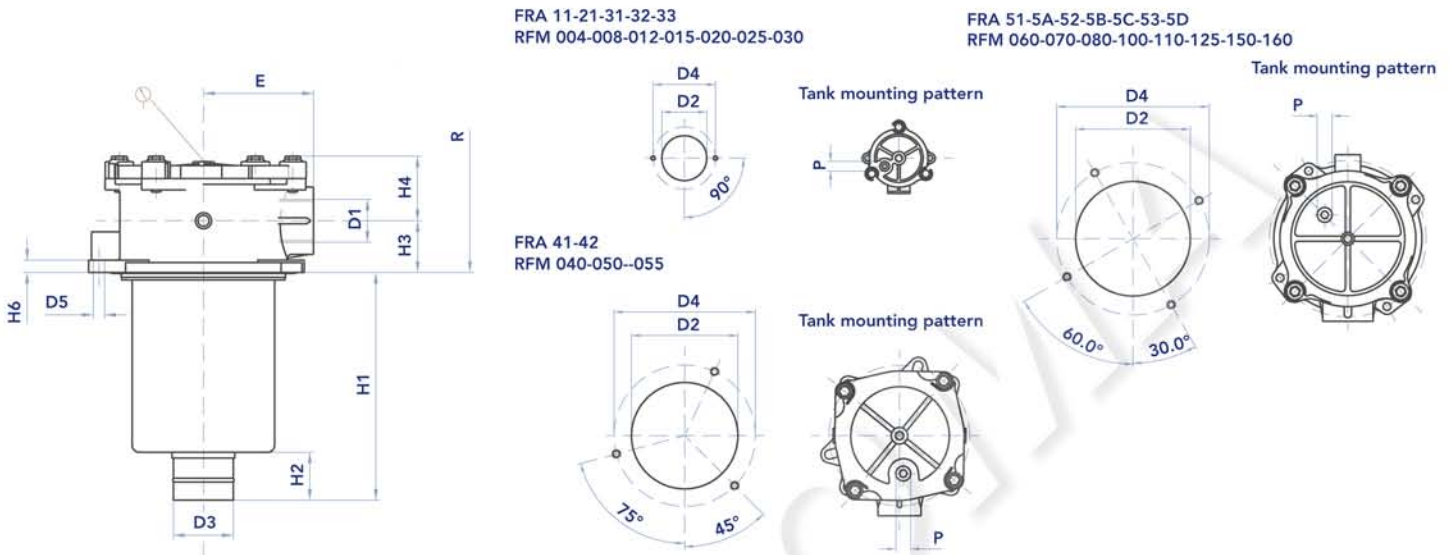

FILTER HOUSING

	D1	min D2	max D2	D3	D4	D5	E	H1	H2	H3	H4	H6	P	R	Kg
FRA11	3/8"	50	50	12	80	6,5	40	59	16	12	33	9	1/8"	90	0,30
FRA21	1/2"	67	68	24	90	6,5	50	85	20	22	33	9	3/8"	120	0,45
FRA31	1/2"-3/4"	89	90	28	115	9	67	107	25	28	47	10	3/8"	150	0,80
FRA32	3/4" - 1"	89	90	28	115	9	67	150	25	28	47	10	3/8"	190	0,95
FRA33	3/4" - 1"	89	90	40	115	9	67	234	30	28	47	10	3/8"	270	1,10
FRA41	1" - 1"1/4 - 1"1/2	126	131	40	175	10,5	95	248	50	35	56	13	1/2"	289	2,10
FRA42	1" - 1"1/4 - 1"1/2	126	131	40	175	10,5	95	268	30	35	56	13	1/2"	306	2,30
FRA51	1"1/4 - 1"1/2 - 2" - 2"1/2	174	180	50	220	10,5	115	178	50	55	69	13	1/2"	250	3,10
FRA5A	1"1/4 - 1"1/2 - 2" - 2"1/2	174	180	50	220	10,5	115	240	50	55	69	13	1/2"	315	3,50
FRA52	1"1/4 - 1"1/2 - 2" - 2"1/2	174	180	63,5	220	10,5	115	240	50	55	69	13	1/2"	315	3,60
FRA5B	2" - 2"1/2	174	180	63,5	220	10,5	115	240	50	55	69	13	1/2"	315	3,65
FRA5C	2" - 2"1/2	174	180	63,5	220	10,5	115	240	50	55	69	13	1/2"	250	3,65
FRA53	2" - 2"1/2	174	180	63,5	220	10,5	115	285	50	55	69	13	1/2"	355	4,10
FRA5D	2" - 2"1/2	174	180	63,5	220	10,5	115	300	50	55	69	13	1/2"	370	4,30



FILTER ELEMENT

	A	B*	C	Kg	AREA (cm ²)		
					Media F+	Media C+	Media M+
ERA11	38	13	50	0,05	270	345	200
ERA21	52	24	70	0,10	310	380	240
ERA31	70	28	85	0,20	620	990	460
ERA32	70	28	130	0,25	1.000	1.600	740
ERA33	70	40	210	0,40	1.660	2.670	1.220
ERA41	99	40	211	0,75	3.800	4.280	1.900
ERA42	99	40	250	0,90	4.550	5.100	2.270
ERA51	130	51	140	1,00	4.140	4.360	1.800
ERA5A	130	51	200	1,10	5.840	6.460	2.730
ERA52	130	63	200	1,35	5.840	6.460	2.700
ERA5B	130	63	200	1,45	7.070	7.070	2.700
ERA5C	130	63	232	1,50	7.280	7.600	3.040
ERA53	130	63	251	1,55	7.500	8.350	3.450
ERA5D	130	63	266	1,60	8.000	8.800	3.730

* Connection dimension



MAINTENANCE

- 1) Stop the system and verify there is no pressure in the filter.
 - 2) Loosen the screws (1) until the cover (2) is free to rotate clockwise.
 - 3) Remove the cover (2) and the spring (3) below. N.B. Handle with care the clogging indicator (7) when present.
 - 4) Remove the dirty filter element (4) using its handle.
- N.B. The exhausted filter elements and the oil dirty filter parts are classified "Dangerous waste material" and must be disposed of according to the local laws, by authorized Companies.
- 5) Check the filter element part number on the filter label or in the ordering and option chart. Use only original spare parts.
 - 6) Lubricate the element o-ring gasket (5) with oil.
 - 7) Insert the clean element into its seat with care.
 - 8) Re-assembly the spring (3).
 - 9) Check the cover o-ring condition (6) and lubricate with oil.
If damaged, check the seal kit part number in the spare seal kit table
 - 10) Re-assembly the cover (2) and tighten the screws (1)

Accessories:

Clogging indicator (7).

If damaged, unscrew and replace it (check the part number in the ordering and option chart). Apply a thread-sealing and screw until tight. N.B. overtightening can damage the thread.

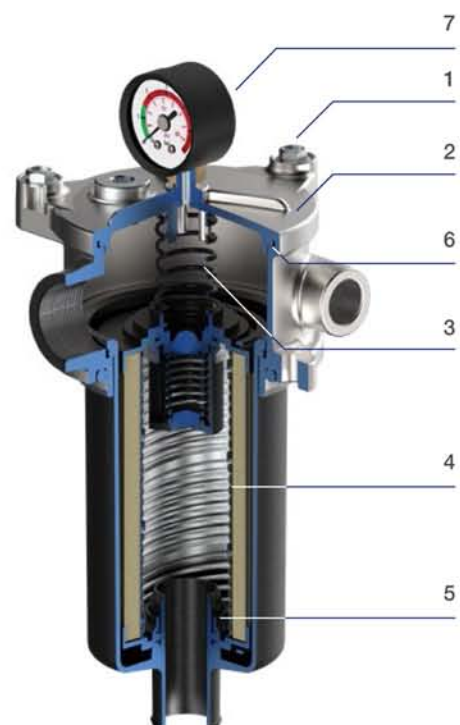

FRA

RETURN FILTERS



PRESSURE DROP CURVES (ΔP)

The "Assembly Pressure Drop (Δp)" is obtained by adding the pressure drop values of the Filter Housing and of the Clean Filter Element corresponding to the considered Flow Rate and it must

be lower than 50 kPa (0,5 bar). In any case this value should never exceed 1/3 of the bypass valve setting.

FILTER HOUSING PRESSURE DROP
(mainly depending on the port size)

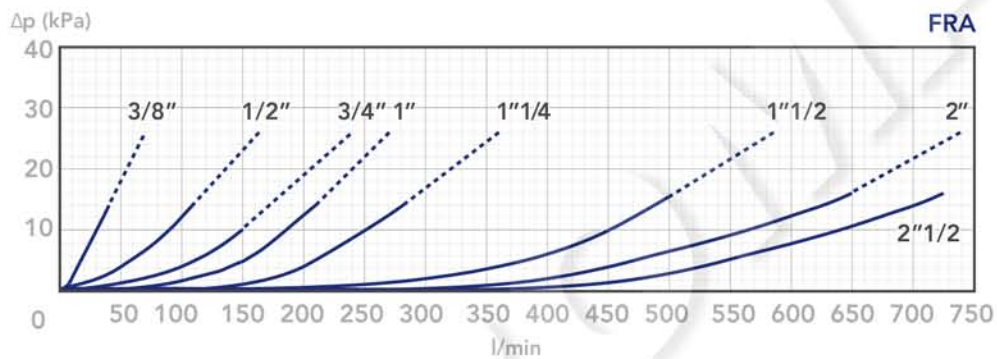

CLEAN FILTER ELEMENT PRESSURE DROP WITH F+, C+ AND ME MEDIA
(depending both on the internal diameter of the element and on the filter media)

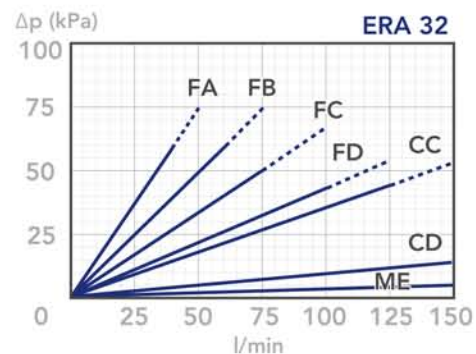
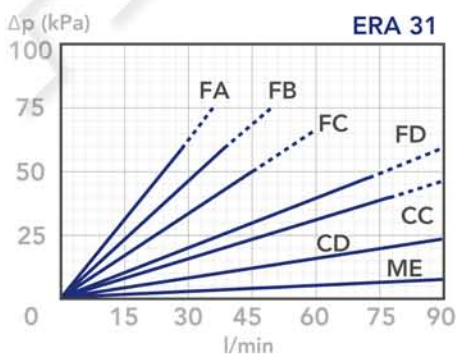
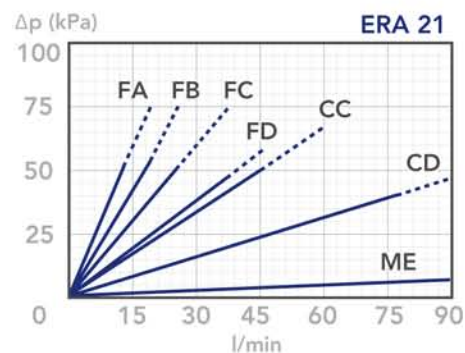
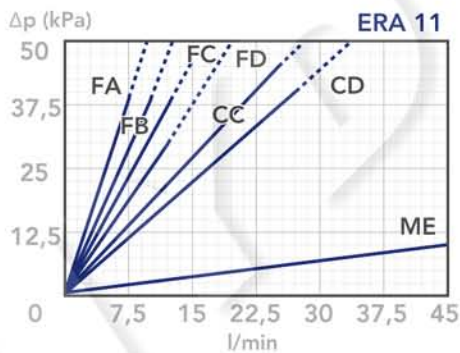

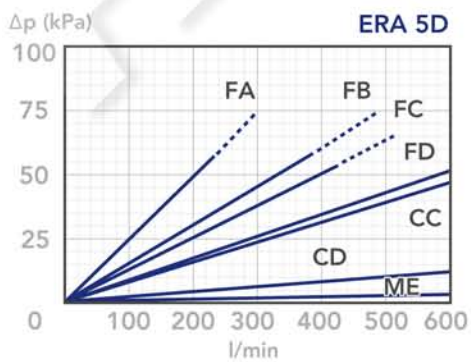
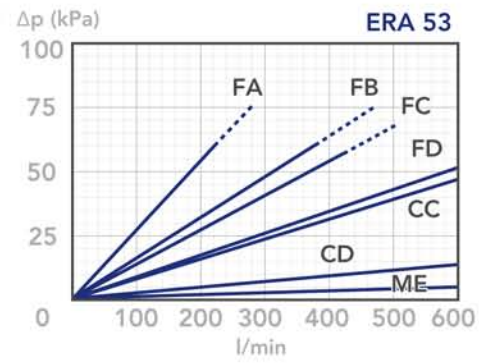
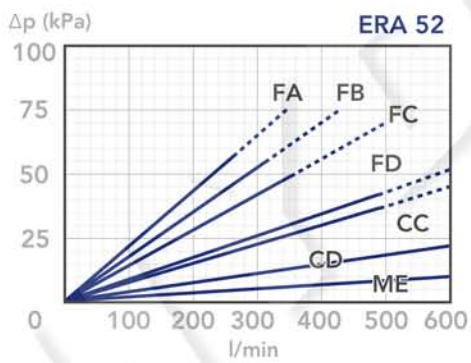
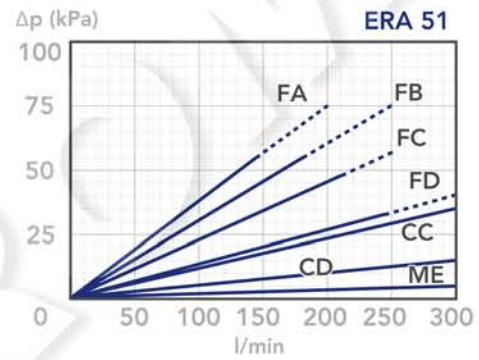
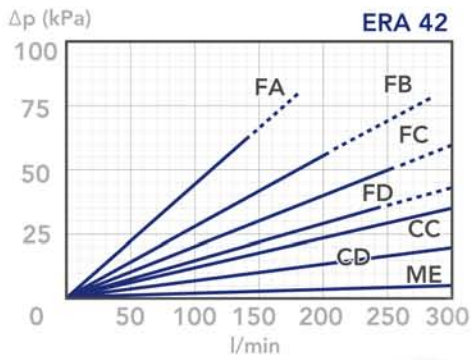
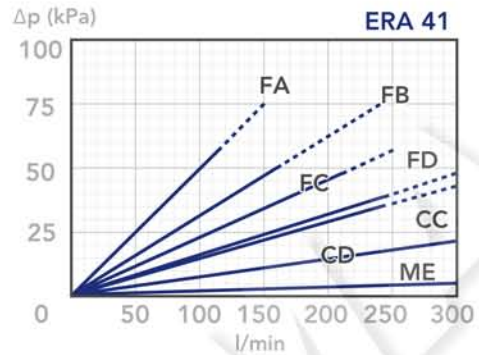
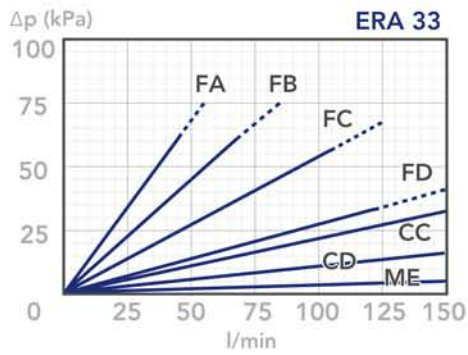

FRA

RETURN FILTERS

BYPASS VALVE PRESSURE DROP

When selecting the filter size, these curves must be taken into account if it is foreseen that any flow peak is to be absorbed by the bypass valve, it also must be of proper configuration to avoid pressure peaks. The valve pressure drop is directly proportional to fluid specific gravity

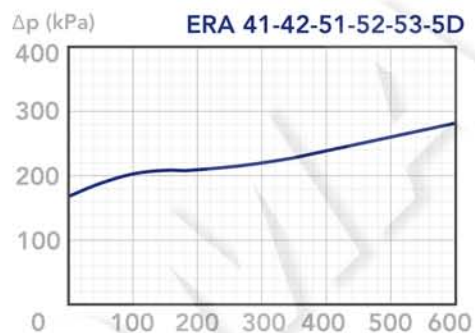
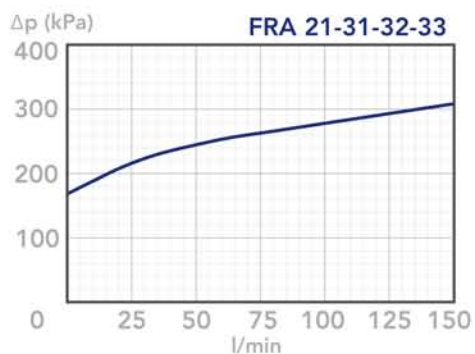

N.B.

All the curves have been obtained with mineral oil having a kinematic viscosity 30 cSt and specific gravity 0,86 kg/dm³; for fluids with different features, please consider the factors described in the first part of this catalogue. All the curves

are obtained from test done at the UFI FILTERS HYDRAULICS Laboratory, according to the specification ISO 3968. In case of discrepancy, please check the contamination level, viscosity and features of the fluid in use.