

Part number:

RE 18329-85/02.16 1/2
Replaces: RE 00162-02/08.10

Insert type Hose burst

VPN1

OT.F4.01 - X - Y - Z

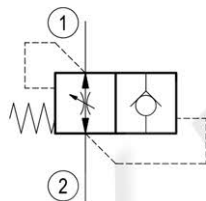
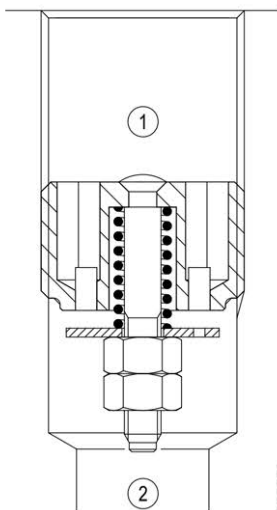

Hose burst check valve

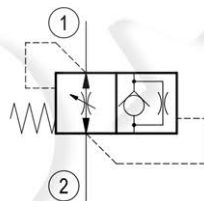

Hose burst check valve
with orifice

Description

When the lowering speed exceeds preset value, as it might happen in case of hose failure, the flow is blocked. These valves should ideally be screwed directly into the actuator outlet port. Sealing parts are superfinished and enable to lock the load in the position where the actuator is in the moment of hose failure. These valves can be supplied, on request, with an orifice on the disc, allowing an emergency lowering of the load. It is recommended to fit a flow regulator valve downstream the hose burst valve, at the end of the flexible hose, to control the lowering speed at the nominal value. The "R" gap must be adjusted to allow a flow at least 50% over the nominal regulated flow from the actuator.

The valve is only supposed to be operated in case of hose failure. Should this circumstance occur, we strongly recommend to verify the integrity of the valve and eventually to replace it in the event that the pressure spike generated by the hose failure was such to damage permanently some valve components.

Note: available also as "Sleeve valve for line mounting"
See data sheets RE 18316-85, RE 18316-86, RE 18316-87 and RE 18316-88

Technical data

Max. operating pressure	bar (psi)	315 (4500)
Max. flow	l/min. (gpm)	see performance graphs ('R'-Q)
Fluid temperature range	°C (°F)	-30 to 100 (-22 to 212)
Installation torque	Nm (ft-lbs)	see "Dimensions" table
Weight	kg (lbs)	see "Dimensions" table
Special cavity		see "Dimensions"
Fluids		Mineral-based or synthetics with lubricating properties at viscosities of 10 to 500 mm ² /s (cSt)
Filtration		Nominal value max. 10µm (NAS 8) ISO 4406 19/17/14
Installation		No restrictions
Other Technical Data		See data sheet RE 18350-50

Dimensions

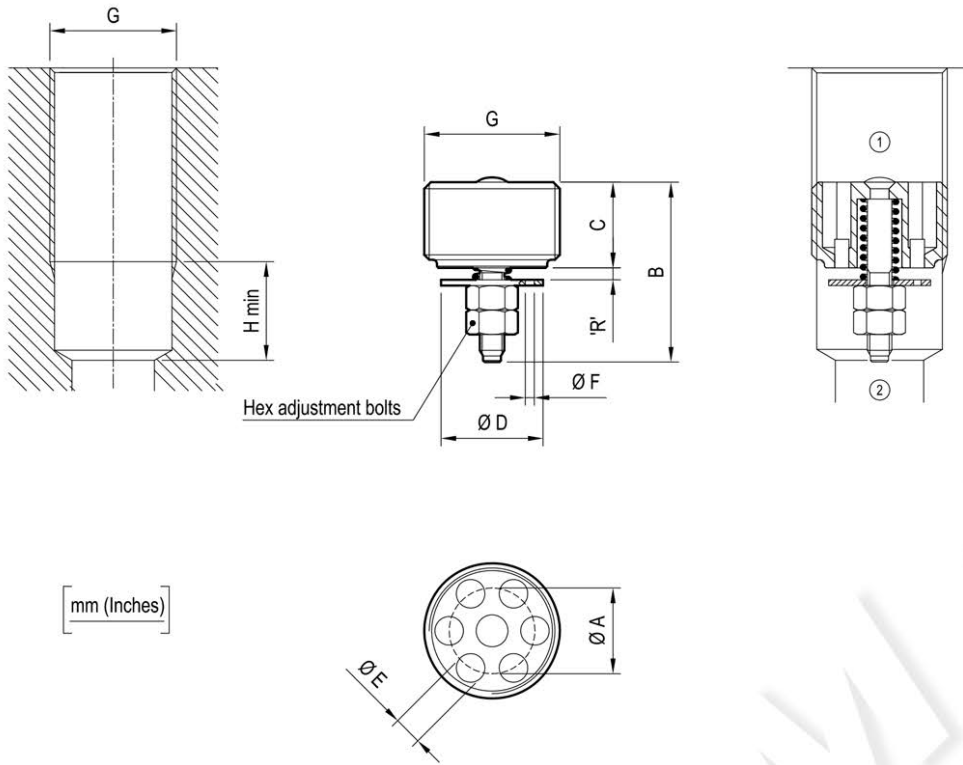

[mm (Inches)]

G *	A	B	C	D	E	F	H	Hex	Weight kg (lbs)	Inst. torque Nm (ft-lbs)	Flow max. l/min. (gpm)	
											min.	max.
G 1/4	8.5 (0.34)	17.5 (0.69)	8 (0.32)	9.5 (0.37)	2.4 (0.1)	on request	11 (0.43)	5.5 (0.22)	0.005 (0.011)	2 (1.5)	4 (1)	25 (7)
G 3/8	10.5 (0.41)	23 (0.91)	10.5 (0.41)	12.5 (0.49)	3.5 (0.14)	on request	11 (0.43)	5.5 (0.22)	0.010 (0.022)	3 (2)	6 (2)	50 (13)
G 1/2	13 (0.51)	25 (0.98)	12 (0.47)	15 (0.59)	4.5 (0.18)	on request	15 (0.59)	7 (0.28)	0.020 (0.044)	4 (3)	16 (4)	80 (21)
G 3/4	16 (0.63)	30.5 (1.2)	17 (0.67)	18 (0.71)	6 (0.24)	on request	16 (0.63)	7 (0.28)	0.042 (0.093)	10 (7)	25 (7)	150 (40)

* Thread in accordance with ISO 228-1

Fitting tool dimensions

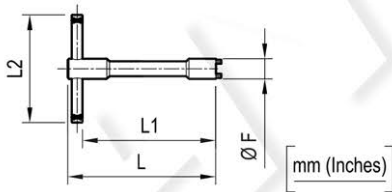

Type	F	L	L1	L2	Tool code	Material number
VPN1.G14	11.3 (0.45)	120 (4.72)	110 (4.33)	60 (2.36)	AVA18	R931002467
VPN1.G38	15 (0.59)	120 (4.72)	108 (4.25)	80 (3.15)	AVA18-01	R931002468
VPN1.G12	18.8 (0.74)	120 (4.72)	108 (4.25)	80 (3.15)	AVA18-02	R931002469
VPN1.G34	24 (0.95)	120 (4.72)	108 (4.25)	80 (3.15)	AVA18-03	R931002470

Performance

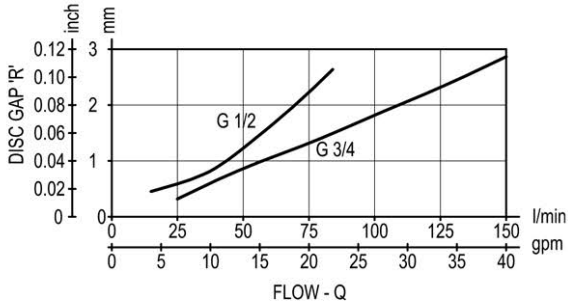
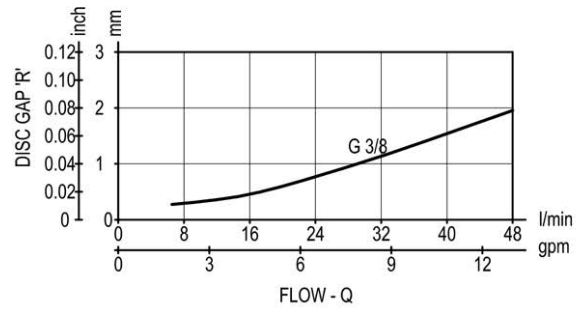
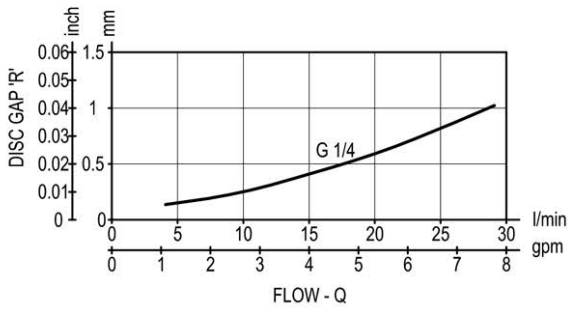

Performance curves R/flow (allowance can be $\pm 10\%$ from the curve)
After assembling the valve are preadjusted at the following values

- 0.5 mm (0.02 in) for G 1/4 and G 3/8
- 0.7 mm (0.03 in) for G 1/2 and G 3/4

Flow performance from '1' to '2' depending on R-length

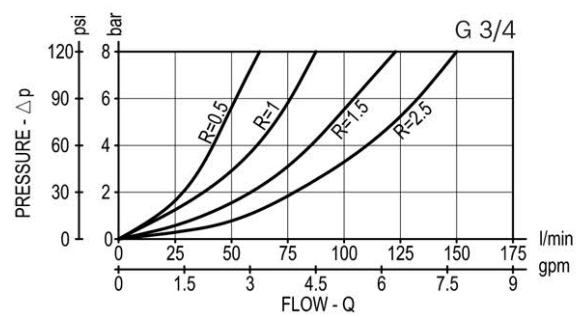
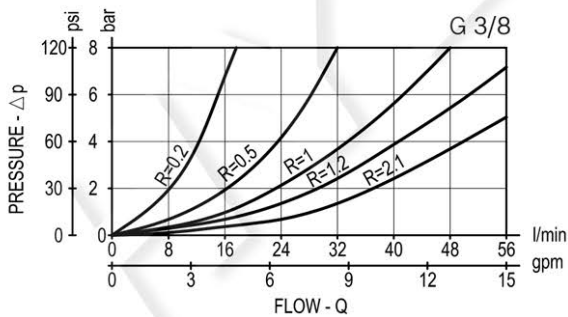
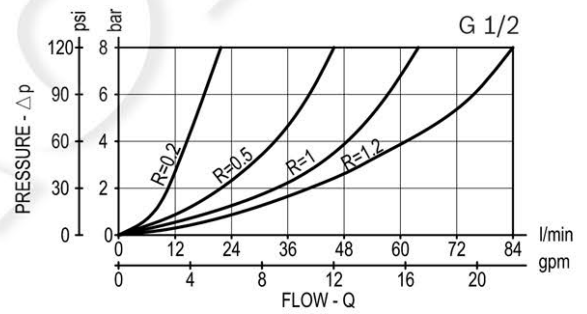
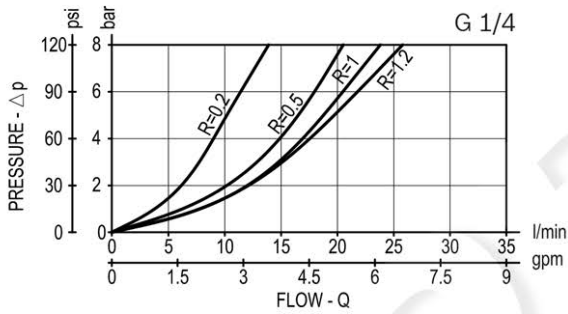

Special flow settings available.
Please contact factory authorized representative for ordering code

Ordering code

OT.F4.01	X	Y	Z	*
----------	---	---	---	---

Series O/A to L
unchanged performances and dimensions

Insert type -
Check, hose burst

Adjustments

= 03 Locking nut + counter nut
see graphs ('R' - Q)

Port sizes

= 09 G 1/4

= 02 G 3/8

= 03 G 1/2

= 04 G 3/4

	Orifice diameter (mm)
= 00	no orifice
= 01	0.5
= 02	0.6
= 03	0.7
= 04	0.8
= 05	0.9
= 06	1
= 07	1.2
= 08	1.3
= 09	1.5
= 10	1.9
= 11	2

Type	Material number
OTF401030200000	R931000017
OTF401030300000	R901127828
OTF401030400000	R901161819
OTF401030900000	R931000021

Type	Material number