

Part number:

076-10061a

HYDROMA

HYDRAULICKÉ SYSTÉMY

**HIDROMA
SYSTEMS**

UKŁADY HYDRAULICZNE

HYDROMA

ГИДРАВЛИЧЕСКИЕ СИСТЕМЫ

1P



Porte standard: filetti M6 profondità utile 12 mm.

Standard ports: M6 thread depth 12 mm.

OPZIONI

"GAS": filetti G3/8 (presenti su entrambi i lati del corpo) profondità utile 12 mm.

OPTIONS

"GAS": G3/8 thread depth 12 mm. Threads are machined on both body sides.

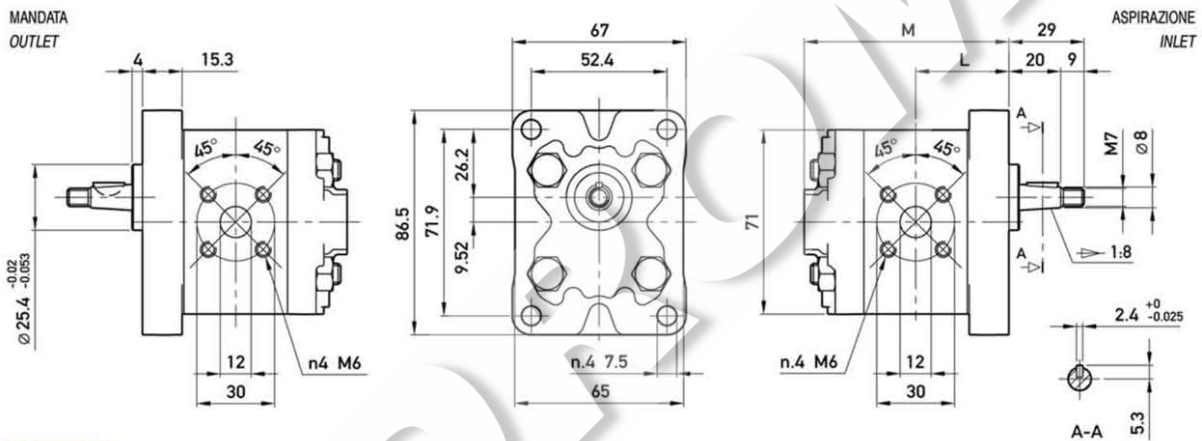

**Opzioni:
Options:**

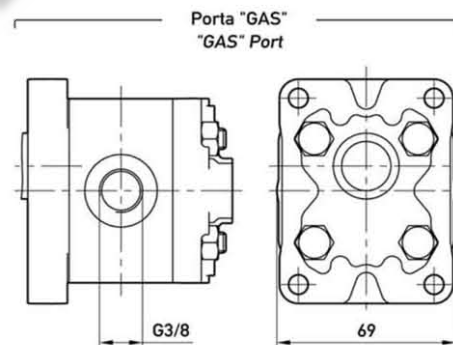
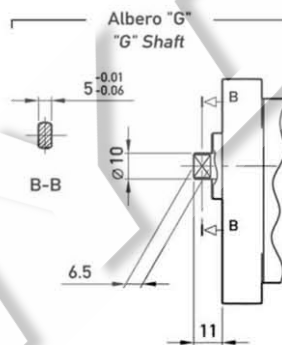

TIPO TYPE	CILINDRATA DISPLACEMENT	PORTATA a 1500 giri/min FLOW at 1500 rev/min	PRESSIONI MASSIME MAX PRESSURE			VELOCITÀ MASSIMA MAX SPEED	DIMENSIONI DIMENSIONS	
			P ₁	P ₂	P ₃		L	M
	cm ³ /giro (cm ³ /rev)	litri/min (litres/min)	bar	bar	bar	giri/min (rpm)	mm	mm
1P D 1,6	1,1	1,6	230	250	270	6000	34	75
1P D 2	1,3	2,0	230	250	270	6000	34,5	76
1P D 2,5	1,6	2,4	230	250	270	6000	35	77
1P D 3,3	2,1	3,2	230	250	270	6000	36	79
1P D 4,2	2,7	4,0	230	250	270	6000	37	81
1P D 5	3,2	4,8	210	230	250	5000	38	83
1P D 5,8	3,7	5,6	210	230	250	4500	39	85
1P D 6,7	4,2	6,4	210	230	250	4000	40	87
1P D 7,5	4,8	7,2	190	210	230	3500	41	89
1P D 9,2	5,8	8,7	190	210	230	3000	43	93
1P D 11,5	8,0	11,9	160	180	200	2100	47	101

Part number:

076-10061b

HYDROMA

HYDRAULICKÉ SYSTÉMY

**HIDROMA
SYSTEMS**

UKŁADY HYDRAULICZNE

HYDROMA

ГИДРАВЛИЧЕСКИЕ СИСТЕМЫ

